



MALAVIYA NATIONAL INSTITUTE OF TECHNOLOGY JAIPUR
JAIPUR – 302017 (RAJASTHAN), INDIA

CERTIFICATE

This is to certify that the dissertation entitled “**A Modified Close Neighbour Algorithm For Designing Cellular Manufacturing System**” being submitted by Amit Bhaskar (2014PIE5385) is a bonafide work carried out by him under my supervision and guidance, and hence approved for submission to the Department of Mechanical Engineering, Malaviya National Institute of Technology Jaipur in partial fulfillment of the requirements for the award of the degree of Master of Technology (M.Tech.) in Industrial Engineering. The matter embodied in this dissertation report has not been submitted anywhere else for the award of any other degree or diploma.

Prof. Rakesh Jain
Professor,
Department of Mechanical Engineering,
MNIT Jaipur
Place: Jaipur
Dated: June 2016



CANDIDATE'S DECLARATION

I hereby declare that the work which is being presented in this dissertation entitled “A modified close neighbour algorithm for designing cellular manufacturing system” in partial fulfilment of the requirements for the award of the degree of Master of Technology (M.Tech.) in Industrial Engineering, and submitted to the Department of Mechanical Engineering, Malaviya National Institute of Technology Jaipur is an authentic record of my own work carried out by me during a period of one year from July 2015 to June 2016 under the guidance and supervision of Prof. Rakesh Jain of the Department of Mechanical Engineering, Malaviya National Institute of Technology Jaipur.

The matter presented in this dissertation embodies the results of my own work and has not been submitted anywhere else for the award of any other degree or diploma.

Amit Bhaskar
(2014PIE5385)

This is to certify that the above statement made by the candidate is correct to the best of my knowledge.

Prof. Rakesh Jain
Supervisor

Place: Jaipur

Date: June 27, 2016

ACKNOWLEDGEMENTS

With great delight, I acknowledge my indebted thanks to my guide and mentor **Prof. Rakesh Jain** who has always been a source of inspiration and encouragement for me. His stimulated guidance and unwavering support always motivated me to reach out for and achieve higher levels of excellence. This dissertation could not have attained its present form, both in content and presentation without his active interest, direction, and help. I am grateful to him for keeping trust in me in all circumstances. I thank him for being big-hearted with any amateurish mistakes of mine.

I express my sincere gratitude to **Prof. A.P.S. Rathore, Prof. Gopal Agrawal, Prof. G.S. Dangayach, Prof. Awadhesh Bhardwaj, Dr. M.L. Mittal and Dr. Gunjan Soni** for their support and guidance throughout the course of study at MNIT Jaipur.

I am extremely thankful to **Prof. Kripa Shankar (IIT KANPUR)** for providing me with his valuable time and inputs since the inception of my studies at MNIT Jaipur. I extend my deep sense of gratitude to him for his cooperation and sharing his immense pool of knowledge.

I am thankful to my senior research scholars at MNIT Jaipur for their support and guidance. I extend my heartiest thanks to my colleagues-friends for their help & support in the accomplishment of this work during my stay at MNIT Jaipur.

Final thanks go to almighty God, my parents **Sri. Arun Kumar Pandey** and **Smt. Indu Pandey**, and my grandfather **Late Sri. Rajendra Prasad Pandey** for their continuous support, encouragement and blessings.

- **Amit Bhaskar**
2014PIE5385

ABSTRACT

In the globalization era, the incessant growth of market totally relies on how efficiently and economically the firms confront the challenges. In the global market, firms have the aim to achieve a higher level of integration between designed and manufacturing functions which lead the operations more efficient and productive. To achieve this objective, it is a challenge for the industrial engineers to involve various approaches and to develop different tools which best suit the problems concern with production.

Group Technology is one of the astonishing achievement in lean production, pledge to confront the challenges. In a similar way, Cellular manufacturing, an application of Group Technology (GT) to manufacturing, is implemented the GT concept by splitting manufacturing systems into cells such that the same cell is processed all alike parts. With the help of CMS, productivity and efficiency in manufacturing firms have been enhanced incessantly through a reduction in lead times, setup times, throughput time, lot sizes, work in process, and the costs relate to material handling, labour, and production equipment.

In this research, we have proposed a method, based on heuristic clustering approach addressed CMS, which overcomes many deficiencies of the close neighbour algorithm in terms of operation sequence and weight of the part proceeded on the machines. This research also presents a mathematical programming formulation as well as an algorithm of the proposed method and for the validation, some standard problems have been taken and verified its results with results of other researchers. These comparisons show that the proposed method offer efficient and reliable solutions for the CMS problem.

Keywords: CMS; Group Technology; Close Neighbour Algorithm; Grouping Efficiency

CONTENTS

| <u>Title</u> | <u>Page No.</u> |
|--|------------------------|
| Certificate | i |
| Candidate's Declaration | ii |
| Plagiarism Report | iii |
| Acknowledgements | iv |
| Abstract | v |
| Contents | vi |
| List of Figures | viii |
| List of Tables | ix |
| Abbreviations | x |
| | |
| 1. INTRODUCTION | 1-6 |
| 1.1. Background | 1 |
| 1.2. Motivation for Research | 4 |
| 1.3. Research Objective | 5 |
| 1.4. Structure of Thesis | 6 |
| | |
| 2. THEORETICAL BACKGROUND & LITERATURE REVIEW | 7-16 |
| 2.1. Introduction | 7 |
| 2.2. Description of various practiced approaches | 9 |
| 2.2.1. Visual Method | 9 |
| 2.2.2. Part Coding Analysis (PCA) | 9 |
| 2.2.3. Production Oriented Method | 9 |
| 2.2.3.1. Cluster Analysis | 10 |
| 2.2.3.2. Graph Theoretic Method | 10 |
| 2.2.3.3. Heuristic Algorithms | 11 |
| 2.2.3.4. Mathematical Programming | 11 |

| | |
|--|---------------|
| 2.2.3.5. Artificial Intelligence | 11 |
| 2.2.3.6. Meta-Heuristic Approach | 11 |
| 2.2.3.7. Hybrid Metaheuristics | 12 |
| 2.3. Objectives considered by researchers..... | 12 |
| 2.4. Heuristic Algorithm: Background..... | 13 |
| 3. METHODOLOGY | 17-24 |
| 3.1. CNA..... | 17 |
| 3.2. Proposed clustering module | 18 |
| 3.2.1. Similarity measure | 19 |
| 3.2.2. Approach..... | 19 |
| 3.2.3. Performance measure..... | 23 |
| 4. ANALYSIS AND RESULTS | 25-44 |
| 5. CONCLUSIONS AND LIMITATIONS | 45-46 |
| REFERENCES | R1-R4 |
| APPENDICES | A1-A11 |
| Appendix A- Matlab code | A1 |
| Appendix B- Literature Review | A4 |

LIST OF FIGURES

| <u>Title</u> | <u>Description</u> | <u>Page No.</u> |
|--------------|--|-----------------|
| Figure 1-1 | Typical Job Shop Layout | 1 |
| Figure 1-2 | Product Layout for Mass Production | 2 |
| Figure 1-3 | Cell Layout for Group Technology | 3 |
| Figure 1-4 | Demonstration of Voids and Exceptional Parts | 4 |
| Figure 1-5 | Manufacturing System Classification | 5 |
| Figure 2-1 | Part grouping Based on geometric similarity | 8 |
| Figure 2-2 | Categories of Grouping Approaches | 9 |
| Figure 3-1 | Flow chart of the Proposed Algorithm | 21 |

LIST OF TABLES

| <u>Title</u> | <u>Description</u> | <u>Page No.</u> |
|---------------------|---|------------------------|
| Table 4-1 | Machine-part matrix- Example 1 (initial matrix) | 25 |
| Table 4-2 | Matrix B | 26 |
| Table 4-3 | Machine clustering in stage 1 | 27 |
| Table 4-4 | The intermediate matrix from stage 1 | 27 |
| Table 4-5 | Clustering parts in stage 2 | 28 |
| Table 4-6 | The Final solution matrix | 28 |
| Table 4-7 | Machine-part incidence matrix- Example 2 | 30 |
| Table 4-8 | The Final solution matrix- Example 2 | 32 |
| Table 4-9 | Machine-part incidence matrix- Example 3 | 33 |
| Table 4-10 | The Final solution matrix- Example 3 | 34 |
| Table 4-11 | Part-machine incidence matrix- Example 4 | 36 |
| Table 4-12 | The Final solution matrix- Example 4 | 37 |
| Table 4-13 | Part-machine incidence matrix- Example 5 | 38 |
| Table 4-14 | The Final solution matrix- Example 5 | 39 |
| Table 4-15 | Part-machine incidence matrix- Example 6 | 41 |
| Table 4-16 | The Final solution matrix- Example 6 | 43 |
| Table 4-17 | Machine-cells and part-families from proposed model | 44 |
| Table 5-1 | Performance of Proposed model on test examples. | 46 |

ABBREVIATIONS

| | |
|------------|--|
| CMS | Cellular Manufacturing System |
| GT | Group Technology |
| WIP | Work-In-Process |
| CNA | Close Neighbour Algorithm |
| PMIM | Part Machine Incidence Matrix |
| TOPSIS | Technique for Order of Preference by Similarity to Ideal Solution |
| SAW | Simple Additive Weighting |
| a | Number of machines |
| b | Number of parts |
| $S_{i,j}$ | Pairwise similarity between machine i and j |
| $X_{i,v}$ | Machine i occupies row v in the final matrix ($X_{i,v}=1$ or 0) |
| $b_{i,j}$ | Matrix element measures the closeness of machine i and j |
| W_t | Weight of the part t |
| r_t | Maximum number of operations for part t |
| c | Maximum number of machine cells |
| η | Grouping efficiency |
| m_c | Number of machines in cell c |
| M | Maximum number of machines allows in any cell |
| p_c | Number of parts in cell c |
| e_0 | Total void (0's) in the diagonal blocks |
| A | Part machine incidence matrix |
| $A(i,t,p)$ | Sequence of part t in p^{th} visit of machine i in matrix A |

- B Matrix formed by $S_{i,j}$
- P_i Number of multi-visit of machine i
- Z_i Sum of non-diagonal matrix B
- n_t Limit of machines in clustering parts
- I Maximum number of intercell travels possible in the system

$$= \sum_{t=1}^b (r_t - 1)$$

- U Number of intercell movements required by the system

$$= \sum_{t=1}^b \sum_{k=1}^{r_t-1} x_{tk}$$

Where $x_{tk} = \begin{cases} 1 & \text{if operation } k, k + 1 \text{ are performed in same cell} \\ 0 & \text{otherwise} \end{cases}$

Chapter 1

INTRODUCTION

1.1. Background

In the globalization era, the incessant growth of market totally relies on how efficiently and economically the firms confront the challenges. In the global market, firms have the aim to achieve a higher level of integration between designed and manufacturing functions which lead the operations more efficient and productive. To achieve this objective, it is a challenge for the industrial engineers to involve various approaches and to develop different tools which best suit the problems concern with production. In order to deal with the challenges, the proactive management and relentless attention on advance technologies in the industries are the best option which in result high performance of manufacturing systems

The very first advancement in manufacturing firm was Craft or Job shop production, led by European firms in the 1880s, used to make the custom products in small batches. Product differentiation is the main target in Craft Production. Part travels across the whole workshop from one department to another for each process. (See figure 1-1). [1]

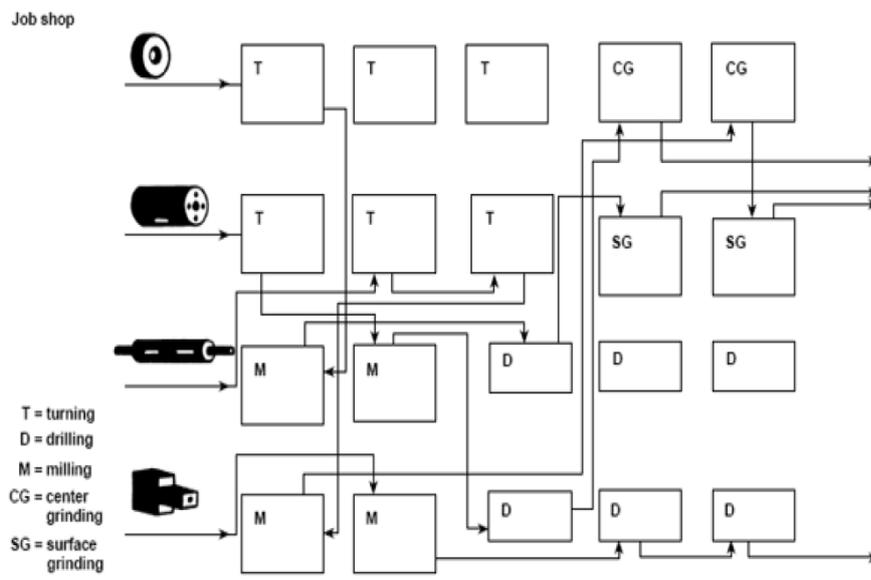

Fig. 1-1 Typical Job Shop Layout

But the problem with it is exclusively high cost, long production run, low machine utilization, high manufacturing lead time and low volume.

After World War I, Henry Ford (Ford Motors) and Alfred Sloan (General Motors) moved world manufacturing from centuries of craft production into the age of mass production [1]. In mass or flow production, standard products are churned out in the vast volume. A dedicated line for each product confronts the shortcoming of craft production. (See Figure 1-2). To avoid disruption, the mass producer has to hold many buffer inventories to ensure smooth production result in high holding cost. Due to standardize design and reluctance in the changeover to a new product, the customer gets the low-cost product at the expense of variety.

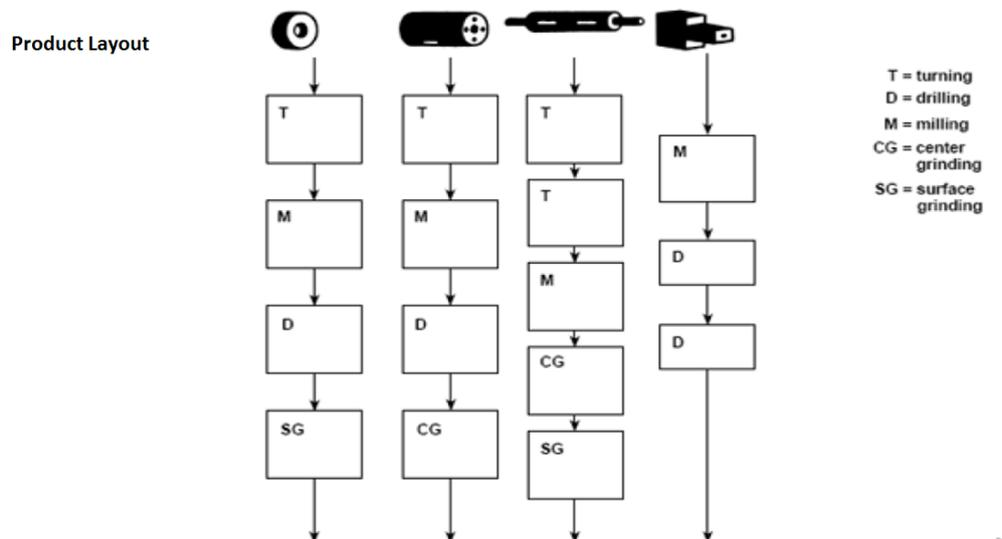

Fig. 1-2 Product Layout for Mass Production

Traditional manufacturing systems caused chaos to fulfill the need of what efficient system is to be, like balance the product variety and volume according to demand. After World War II, it was the Japanese who set out the changes in the rules of the games. Eiji Toyoda and Taiichi Ohno (Toyota Motors) pioneered the new concept of lean production, combined the advantages of craft production and mass production, while avoiding the rigidity of later and the high cost of the former. Now all vestiges of product

and process layout, once the way of all the industries are now gone except few places still in practice.

Lean production is rife with tools and technique where Group Technology is one of the astonishing achievement. In GT, Products are produced in batches (groups), a single production line can be used to produce several products. Thus, it also calls as Batch production. (See figure 1-3). It pays relentless attention to prevent long production run, high WIP inventories, low machine utilization, high manufacturing lead time and cause endless quest for perfection in a manufacturing system.

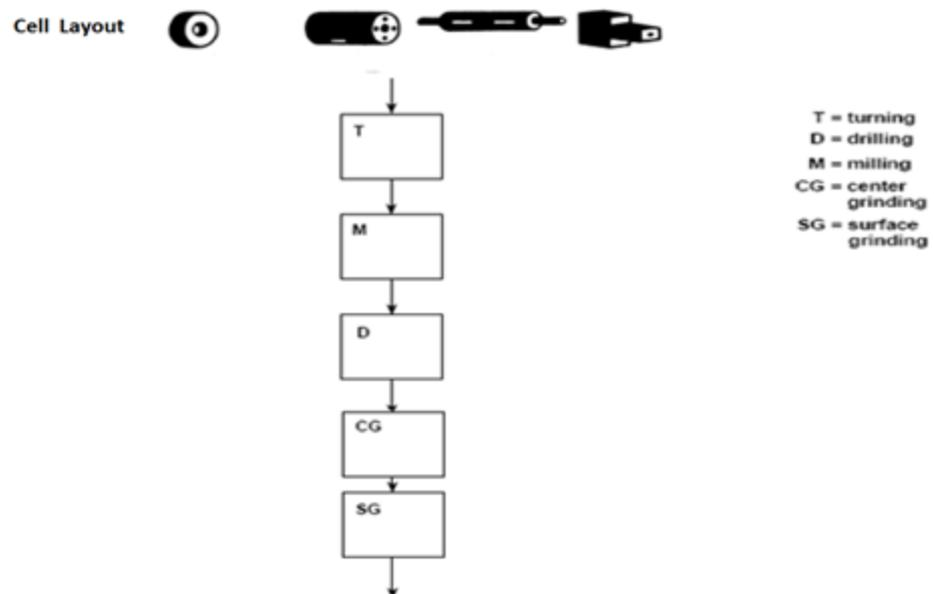

Fig. 1-3 Cell Layout for Group Technology

In a similar way, Cellular manufacturing, an application of Group Technology (GT) to manufacturing, is implemented the GT concept by splitting manufacturing systems into cells such that the same cell is processed all alike parts. It allows the better control of product flow over machines from entering into the system to finished goods. In CMS, first to identify parts and machine types in PMIM that to be considered in cellular formation. In PMIM, rows and column represent machines set and part types, respectively. The main objective is to group the parts into part families and machines

into cells so that zero intercell moves and zero void i.e. blank spaces which show unutilization of machines in cell/family. Intercell moves are technically measured with bottleneck machine i.e. machine processes the parts which belong to another cell/family; and exceptional part i.e. a part requires machine which belongs to another cell/family. (See figure 1-4).

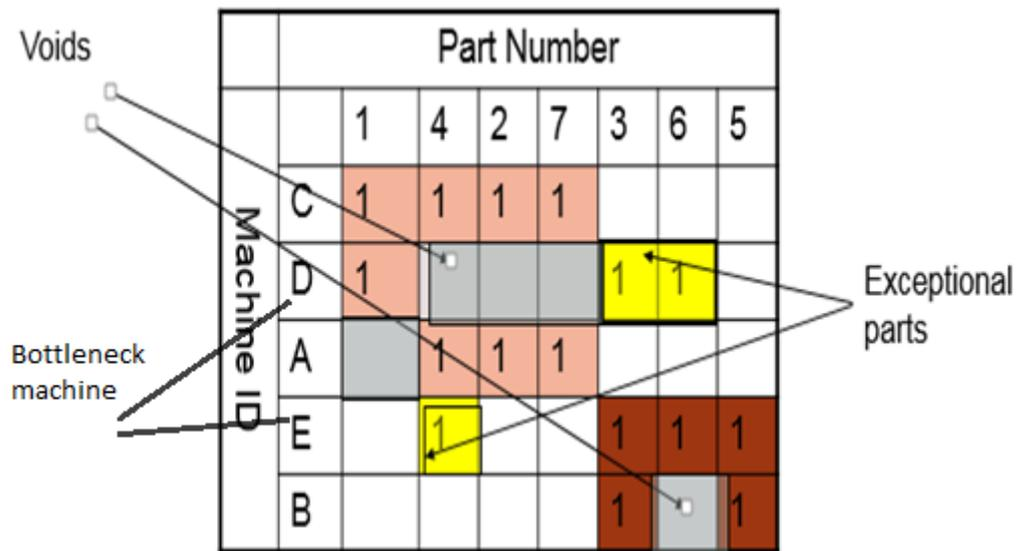

Fig. 1-4 Demonstration of Voids and Exceptional Parts

So, the prior study acquainted with manufacturing system categorizes the manufacturing layout as followed: Product Layout, Process Layout, and Cellular Manufacturing Layout (See figure 1-5) [2]

1.2. Motivation for Research

Since in GT/batch production, the parts are proceeded in batches from one process to another process, each part of a batch must wait for the remaining parts in its batch to complete its process before moved to the next stage. Literature study suggests, it leads to increased production time, high level of in-process inventory, high production cost, and low production rate. Consequences of this, the researchers are more concern on GT/batch production over job shop production and mass production. But the constraints

like maximum machines in cells, volume and demand of products, sequence order, flexible routing and so on, have bound their pace. The endless quest for perfection in GT continues to generate surprising results. Thus, CMS is rife with methods and mathematical models (See Appendix-B) but none of them are considered all of the constraints, simultaneously. This study pledges to develop a method that can consider all of the constraints.

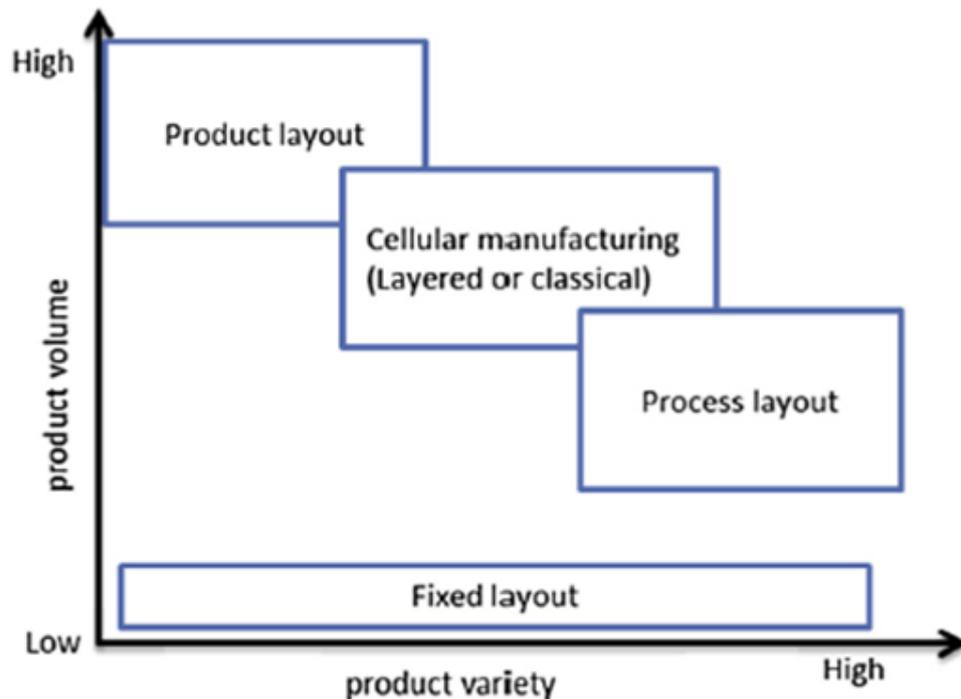

Fig. 1-5 Manufacturing System Classification (Adopted from Süer et.al., 2010)

1.3. Research Objective

The objective of this research is to devise a framework that helps to solve the current problem in GT and allows the smooth flow and control of materials in batch production. Literature study reveals the traditional methods in GT are not sufficient to deal with product demand uncertainty, production volume and the sequences in which parts are processed through one machine to another machine. So, proposed study has to take care of those constraints, so that the results come out from this method must be closed to the actuality.

The specific research objectives of the study undertaken as follow:

- a) To develop a sequence-based similarity measure between machines.
- b) To develop a heuristic model to confront some natural inputs data and constraints met in real life production systems.
- c) To develop a grouping efficiency model for comparison of proposed result to result pioneered by the researchers.

1.4. Structure of thesis

The remainder of this thesis consists of 5 chapters. The structure of this dissertation is as followed: Chapter 2 confronts what GT and CMS are, which followed by classification of different methods practiced by researchers in GT. Continue with a vast description on a literature review and methods practiced in GT. In the next chapter i.e. chapter 3, methodology is discussed, with the brief introduction of Close Neighbour algorithm (CNA) and its pros and cons. Further proposed a method which is a modified version of CNA, is pioneered along with a mathematical linear model. For performance measure, a method is pioneered called Grouping Efficiency. In chapter 4, some standard problems concerned by different researchers, are taken into account for applying in proposed model. The result is further compared with other researcher's models. In chapter 5, the whole study is concluded with the results and provided some future works that are not considered in this study.

Chapter 2

THEORETICAL BACKGROUND & LITERATURE REVIEW

2.1. Introduction

Since GT is an old concept of grouping the similar things in one place, allowed the control over the material flow so that it ensures to be ease of control. Grouping may include part, machine, processes etc. to reduce set-up time, lead time, WIP and material handling, etc. Many researchers are tried to devise GT in their own way. According to Durie (1970) “ The replacing of traditional job shop manufacturing by the analysis and grouping of work into families and the formation of groups of machines to manufacture these families on a flow line principle with the object of minimizing setting and throughput times.” [1]

Family formation is relied on similarities, based on two attributes: manufacturing attributes and design attributes. Manufacturing attributes involve operational processes similarity whereas design attributes involve geometric shape and size to form families.

As per growth in the automation field, present scenario is much pioneered about JIT and lean manufacturing whose basic concept is to minimize the waste and smoothen the process. Seeing closely, these concepts are nothing but a replica of CMS in advance form. So going in the direction of lean and JIT, first have to understand the concept of GT. Figure 2 shows 8 distinguish parts of different geometric and shapes, usually processed in different types of process layout for each individual part. But the close observation of these parts, there is some design similarity. So if these parts are processed in the two-part family, in result only two layouts are required for processing all parts. That is the concept of GT.

In a similar way, Cellular manufacturing, an application of Group Technology (GT) to manufacturing,[3] is implemented the GT concept by splitting manufacturing systems into cells such that the same cell is processed all alike parts. It is a technique for enhancing productivity and efficiency in manufacturing firms through reducing lead times, setup times, throughput time, lot sizes, work in process, and the costs related to

material handling, labour, and production equipment. In compare with the traditional job-shop layout, it's allowed the better control of product flow over machines from entering into the system to finished goods.

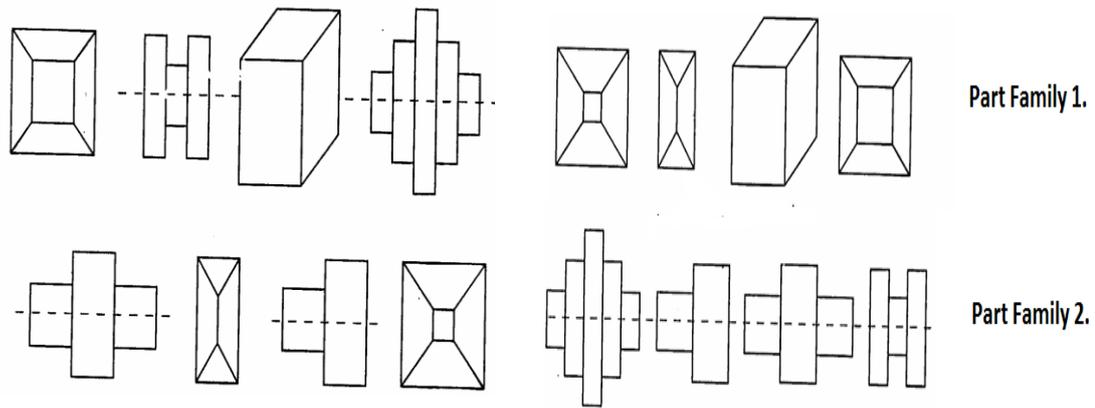

Fig. 2-1 Part grouping Based on geometric similarity

Based on given set of part types, processing essentials, and part type demands, the design of Cellular manufacturing consists of the following: (a) based on part processing, first part families are formed, (b) machines are grouped into machine cells, and, (c) part families are assigned to that cells. Note that most of the time these steps perform in the above order but not necessarily. Three solution strategies are established based on methodology used to configure machine cells and part families as follows: (a) part machine identification (PFI), i.e. part families are formed first and then according to part families, machines are grouped into cell, (b) machine groups identification (MGI), based on similarity in part routing, machine cells are configured first and then the parts are assigned to cells, and (c) part families/machine grouping solution strategy (PF/MG), machine cells and part families are configured together.

Matrifanov [4] had first pioneered GT in 1966, while Burbidge [5] had propagated it in 1971. In the next five decades, numerous solution methodology have been proposed by the researchers to compute part families and machine cells for finding an isolated partition wherein each part of a part family is remained confined to one machine cell. Good and useful discussions with quality research on CMS can be found in Joines J.A

[6], Selim H.M. [7], Papaioannou G. [8] and Ghosh, T. [9]. A methodological classification of the existing approaches to solve CFP are as follows in Figure 3 and the detailed descriptions are given accordingly as a taxonomic framework.

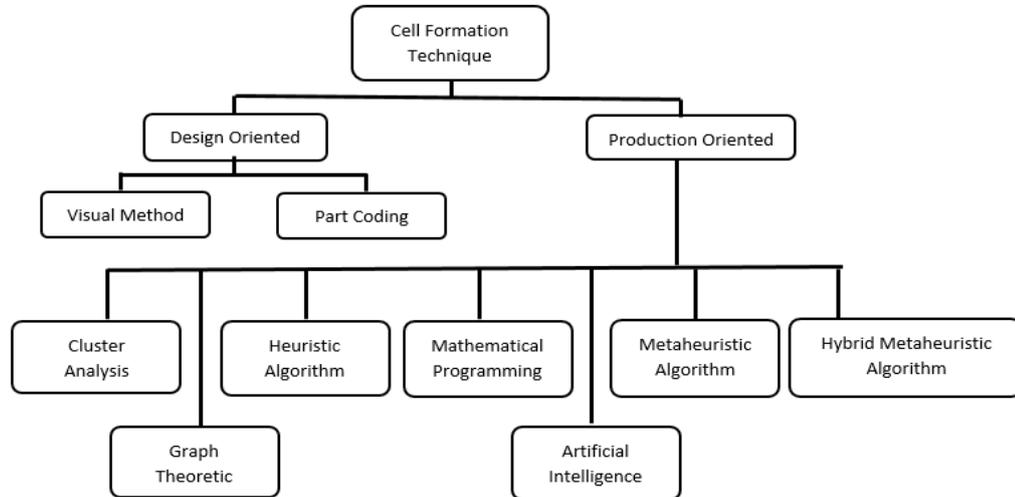

Fig. 2-2 Categories of Grouping Approaches

2.2. Description of various practiced approaches

2.2.1. Visual Methods

Visual methods or informal methods or tacit judgement methods is found as to group part families and machine cells based on subjective judgement or visual identification. This methodology is trivial only with considerable flows of parts over machines.

2.2.2. Part Coding Analysis (PCA)

Part coding analysis (PCA) is based on identifying similarities and differences among parts and assigned them into families by means of a coding scheme. These systems are shape based or design oriented. PCA based systems are considered as an ideal for part variety reduction.

2.2.3. Production Oriented Method

Production oriented method or production flow analysis has been proposed by Burbidge [10], is found as to group part families and machine cells based on information contained on the route sheet. Parts that go through common operations are grouped into part families. This core classification can further be classified as follow.

2.2.3.1. Cluster Analysis

Cluster analysis is found as to group either attributes or entities or objects into clusters so that within a cluster individual elements have a high degree of “natural” association among themselves and very little “natural” association between clusters. It can be further classified as Array-based sorting, Hierarchical clustering, and Non-hierarchical clustering. The **Array Based Sorting Methods** depend on the part machine incidence matrix (PMIM), where the rows and columns represent machines and parts respectively. In PMIM each column is an array of ‘0-1’ indicates part visits in the respective machine. The well-known array based sorting methods are; Bond Energy Algorithm [11], Direct Clustering Algorithm [12], Rank Order Clustering [13]. The **Hierarchical Clustering Methods** are defined as an input data set in term of distance or similarity function, which develops a hierarchy of partitions or clusters. In the hierarchy of each similarity level, different numbers of clusters can be associated with different members. The well-known hierarchical clustering methods are; Single Linkage [14], Average Linkage [15], Complete Linkage [16] and also by dissimilarity measure [17]. **Non-Hierarchical Clustering** is an iterative method based on either the choice of few seed points or an initial partition of the dataset. But in both the cases, total clusters has to decide first. The well-known non-hierarchical clustering methods are- Ideal Seed Non-hierarchical clustering [18], ZODIAC [19] and GRAFICS [20]. The most recent Nair and Narendran [21] has proposed non-hierarchical procedures.

2.2.3.2. Graph-Theoretic Method

Graph theoretic method is found as to address the machines as nodes and the parts denote as arcs linking these nodes. In order to identify manufacturing

cells, this method is approached to disconnect subgraphs from a machine-part or machine-machine graph. [22, 23, 24]

2.2.3.3. Heuristic Algorithms

Heuristic algorithms are found as an alternative framework to solve a problem having a set of non-varying restricted rules-constraints. Though it does not assure to provide optimal solutions but mostly sub-optimal results derive. Therefore, it may be considered as approximately or not accurate algorithms but an acceptable solution that can get in reasonable time. [25, 25, 26, 27, 28, 29, 30]

2.2.3.4. Mathematical Programming

Mathematical programming methods are based on formulation with the objective of either minimizing cost function or maximizing benefit function or both. It can be used where a wide range of manufacturing data involved. Based on the formulation, it can be further classified into four groups; (a) linear programming (LP), (b) Linear and quadratic Integer programming (LQP), (c) dynamic programming (DP), and (d) goal programming (GP). Purcheck [31] has proposed LP based CF methods while Ballakur [32], Kumar et al. [33] have proposed LQP. Ballakur [32] has developed DP models while Sankaran [34] and Shafer and Rogers [35] have proposed GP models.

2.2.3.5. Artificial Intelligence

Many researchers are focused on AI methods to solve the problem of part-machine grouping. However, the most manufacturing data that are computationally intractable and realistically large-scale data sets involved in CF model can be solved with the good result using AI. AI model can be further classified as neural network [36] and fuzzy mathematics [37].

2.2.3.6. Meta-Heuristic Approach

From the past two decades, Meta-heuristic approaches is a growing research area, often nature-inspired. It is a high level heuristic design to find, generate, or select heuristic that may provide a sufficiently good solution to an optimization problem, especially with incomplete or imperfect information or limited computational capacity.

Meta-heuristic approaches can be classified as follows; Tabu Search[38], Simulated Annealing[39], Evolutionary Algorithm(i.e. evolutionary programming[40], genetic programming[41], differential evolution[42], scatter search[43], memetic algorithm[44], genetic algorithms[45], particle swarm optimization[46], bacteria foraging optimization algorithm[47]), Ant Colony Optimization[48], Water Flow-like Algorithm[49], Bees Algorithm[50].

2.2.3.7 Hybrid Metaheuristics

Over the last decade, Hybrid metaheuristics methods are the emerging research area where the new method based on metaheuristic combines with other optimization methods are allowed a higher flexibility and more efficient behavior to find optimal cell formation [51,52,53].

2.3. Objectives considered by researchers

Tabulating (Appendix A) the research paper, help us to contemplate the growth of GT since its beginning. The researchers are considered different types of the objective to solve the grouping problems. Some are noted as followed

- ❖ Minimization of the number of the exceptional parts.
- ❖ Minimization of the number, cost or weighted distance of inter-cell moves of EPs.
- ❖ Minimization of the opportunity cost of EPs.
- ❖ Minimization of the cost of duplicate machines.
- ❖ Minimization of the machine allocation costs.
- ❖ Minimization of the inter-cell capacity balance.
- ❖ Minimization of the load imbalance within cells.
- ❖ Maximization of capacity utilization.
- ❖ Minimization of the conversion costs.

- ❖ Maximization of the sum of similarities.
- ❖ Minimization of the setup time
- ❖ Level of WIP
- ❖ Inter-cell and/or intra-cell move
- ❖ Machine investment/modification/relocation
- ❖ Cell load variation
- ❖ Count of EPs and/or Voids/Operational sequence/time
- ❖ Machine utilization/cycle time of parts
- ❖ Machine duplication & part subcontracting
- ❖ System under-utilization/ cells utilization/system reliability
- ❖ Part processing time/cost/total work content of parts

2.4. Heuristic Algorithms: Background

Heuristic, is any approach to problem solving, learning, or discovery that employs a practical method not guaranteed to be optimal or perfect, but sufficient for the immediate goals. Where finding an optimal solution is impossible or impractical, heuristic methods can be used to speed up the process of finding a satisfactory solution. Heuristics can be mental shortcuts that ease the cognitive load of making a decision. Examples of this method include using a rule of thumb, an educated guess, an intuitive judgment, stereotyping, profiling, or common sense

Heuristic algorithms are found as an alternative framework to solve a problem having a set of non-varying restricted rules-constraints. Though it does not assure to provide optimal solutions but mostly sub-optimal results derive. Therefore, it may be considered as approximately or not accurate algorithms but an acceptable solution that can get in reasonable time. A number of various research paper published on heuristic algorithm for various parameter are discussed below.

Kumar et. al. (1986) has presented a new method for using a subcontracting strategy to induce manufacturing efficiency by re-organizing the existing parts and machines into disaggregated cells. Two efficient algorithms are developed which identify the minimal number or minimal total cost of sub contractible parts while achieving disaggregation. The method has the flexibility of letting the designer control the number of cells and cell size thus generating a variety of cellular manufacturing system designs to choose from.

Boe et. al. (1991) has developed ‘close neighbour algorithm’ that addressed problems of machine and part grouping in cellular manufacturing when the traditional method had failed to produce a solution matrix that has a block diagonal structure, making visual identification of machine groups and part families. This algorithm is tested against ten existing algorithms in solving test problems from the literature. A 0-1 integer model is formulated to represent the problems.

$$\text{Max} \sum_{v=1}^{a-1} \sum_{i=1}^a \sum_{\substack{j=1 \\ i \neq j}}^a b_{i,j} \cdot X_{i,v} \cdot X_{j,v+1}$$

$$\begin{aligned} \text{S.T.} \quad & \sum_{v=1}^a X_{i,v} = 1 && \text{For all } i \\ & X_{i,v} = \{0,1\} && \text{For all } i \text{ and } v \end{aligned}$$

Where,

$A = \{a_{it}\}$ the initial machine and part incidence matrix, where

$$a_{it} = \begin{cases} 1 & \text{if part } t \text{ visits machine } i; \\ 0 & \text{otherwise} \end{cases}$$

$B = \{b_{ij}\}$ the closeness matrix, where

$$b_{ij} = \sum_{t=1}^b a_{it} * a_{jt}$$

A matrix element b_{ij} measures the closeness of machine i and j .

$$x_{iv} = \begin{cases} 1 & \text{if machine } i \text{ occupies row } v \text{ in the final matrix} \\ 0 & \text{otherwise} \end{cases}$$

Logendran et al. (1995) has presented a realistic cell formation problem in the design of cellular manufacturing systems which includes three important features. First, when multiple units of a machine type are considered due to processing time requirements. Second, the model accounts for the possibility of performing two or more nonconsecutive operations of a part on the same machine. Finally, the model allows for splitting the lot into two if the total workload required of a part's operation on a machine exceeded its daily unit capacity expressed in manned hours. The model formulated for the problem falls into the class of generalized quadratic binary programming models. The results obtained show a reduction of more than 50% in total moves (material handling costs) between the initial solution and the final best solution.

Mukattash et al. (2002) has proposed three heuristic procedures. In the presence of alternative process plans, multiple alternative machines and processing times, heuristics are designed to assign parts into the cells for given cell formation (CF) solutions. CF based on alternative process plans and multiple types of machines led to the elimination of exceptional elements. The exceptional elements can be further added to the bottleneck machines that increasing machine utilization. The heuristics are tested using small problem sizes.

Chan et al. (2003) has developed a heuristic algorithm that addressed problems of machine allocation in cellular manufacturing only when the intra-cell materials flow is taken into account. The proposed algorithm is used an adaptive approach to relate machines in a cell by examining the merged part flow weights of machine pairs. The establishment of the part flow weight includes practical constraints, such as the part-handling factor and the number of parts per transportation. The objective function employed is to minimize the total travelling score within one cell in which the total

travelling distance was covered. The current algorithm is compared with other approaches as it provided near optimum solutions.

Kim et al. (2004) has considered a more comprehensive CF problem with a multi-objective machine formulation. Part route families and machine cells are needed to be determined in such a way that minimization of the total sum of intercell part movements and maximum machine workload imbalance could be achieved. A two-phase heuristic algorithm is proposed. In the first phase, representative part routes with part route families are determined whereas in the second phase the remaining part routes are allocated to part route families. The authors concluded that the two-phase heuristic algorithm is effective in minimizing intercell part movements and maximum machine workload imbalance.

Ossama et. al. (2014) has developed a mixed integer programming model to form simultaneously the part families and corresponding cell configurations in reconfigurable manufacturing system (RMS) in a dynamic production environment. The effective design of a RMS exerts the need for a design approach to group the parts into families and determine the corresponding system configurations. A novel reconfiguration planning heuristic, responsible for determining the configuration plan on both machines and system levels between successive time periods, is introduced. This model is tested by solving a dynamic cell formation problem and it is able to find the optimal solution found in the literature.

Chapter 3

METHODOLOGY

Generally, a research is started with a collection of particulars from the existing literature to get equipped with the latest development in the area of research. It's helped to build a theoretical background which is needed to propose a new research hypothesis. This hypothesis is then tested on the suitable platform, and the results are evaluated to prove the proposed work as a distribution in the concerned area. The main purpose of this chapter is to give an overview of research methodology used in this research in order to fulfil the research objectives.

Literature (Appendix B) reveals that there are very few research works, have been made in the direction of the sequencing of machine and scheduling in GT. Very few researchers are tried to consider the weight factor includes parts demand, parts volume, volume production per day etc. This has motivated this research for further work. Now the problem is, which kind of method should use from a pile of methods. Moreover, heuristic methods are easy to understand and have a vital role in solving the problems in less computation time, although it's having few limitations regarding huge data handling. After a thorough study of heuristic approaches, it is found that Close Neighbour Algorithm developed by Boe and Cheng [54], provided the best result in basic PMIM 0-1 array problem. So its concept can be used to solve sequencing problem in cell formation. But the approach is to be modified based on operational sequence and weight of the parts to solve CMS problem. Further detail on CNA is noted as follows.

3.1. CNA

CNA technique provides the following advantages over other clustering methods;

1. It always gives a block diagonal solution matrix. The natural machine and part grouping are immediately apparent from the solution. The ability of this algorithm does not affect by the presence of bottleneck machines and exceptional parts to give a solution matrix in a desirable structure. So non-overlapping machine cells can be formed.

2. This algorithm requires only one run to give a solution.
3. Distortions that may cause by arbitrary human decisions can be avoided because it does not require the user to distinguish bottleneck machines and exceptional parts.

CNA method consists of two stages; the first stage clusters the machines and the second stage works on the column.

$A = \{a_{it}\}$ the initial machine and part incidence matrix, where

$$a_{it} = \begin{cases} 1 & \text{if part } t \text{ visits machine } i \\ 0 & \text{otherwise} \end{cases}$$

$B = \{b_{ij}\}$ the closeness matrix, where

$$b_{ij} = \sum_{t=1}^b a_{it} * a_{jt}$$

A matrix element b_{ij} measures the closeness of machine i and j .

$$X_{iv} = \begin{cases} 1 & \text{if machine } i \text{ occupies row } v \text{ in the final matrix} \\ 0 & \text{otherwise} \end{cases}$$

Cons: Existing method is not considered natural input data. Sequencing of machines i.e. order in which parts are processed into machine, are absent. Weight factor that deal with demand, volume, cost, processing time etc. is also not considered.

3. 2. PROPOSED CLUSTERING MODULE:

The proposed method is based on applying similarity measure in CNA helped to incorporate the problem of operation sequence and weight assignment of the parts.

3.2.1. Similarity measure:

Nair and Narendran [21] is introduced a weighted machine sequence similarity, which is directly taken by this proposed paper for similarity measure which adequate provision to consolidate the factors like weight and operation sequences of parts.

$$S_{i,j} = \frac{\sum_{t=1}^b w_t (\sum_{p=1}^{P_i} d_{itp} + \sum_{p=1}^{P_j} d_{jtp})}{\sum_{t=1}^b w_t (\sum_{p=1}^{P_i} e_{itp} + \sum_{p=1}^{P_j} e_{jtp})} \quad (1)$$

Where

$$e_{itp} = \begin{cases} 0 & \text{if } A(i, t, p) = 0 \\ 1 & \text{if } A(i, t, p) = 1 \text{ or } r_j \\ 2 & \text{otherwise} \end{cases}$$

$$d_{jtp} = \begin{cases} 0 & \text{if } A(j, t, p) = A(i, t, p) = 0 \\ 1 & \text{if } A(j, t, p) = 1 \text{ or } r_j \\ 2 & \text{otherwise} \end{cases}$$

Note: Similarity measure of the machine with itself is always one. ($S_{i,j} = 1 \forall i = j$)

Each machine from the data is generally shared a distinct relationship with other machines. Some machines are strongly connected (high similarity value) when almost the same parts are processed by them. Some are totally luxated (zero similarity) from each other.

3.2.2. Approach:

The approach is rested on three premises:

- (1) Identification of similarity measures between the pair of the machine.
- (2) Grouping the maximum similarity measure.
- (3) A criterion for clustering.

The proposed method consists of two stages; very first to cluster machine, followed by clustering column of matrix A. In the first stage, the desirable machines arrangement in the final matrix is obtained. At first, with the element $S_{i,j}$, matrix B is constructed, represented how strongly machines i and j are connected in part routings. The higher the value of $S_{i,j}$, the closer machine i and j are positioned to each other in the final matrix. Therefore, a 0-1 polynomial programming model with linear constraints can be formulated to represent the problem as follows.

$$\text{Max} \sum_{v=1}^{a-1} \sum_{i=1}^a \sum_{\substack{j=1 \\ i \neq j}}^a S_{i,j} \cdot X_{i,v} \cdot X_{j,v+1}$$

$$\text{S.T.} \quad \sum_{v=1}^a X_{i,v} = 1 \quad \text{For } \forall i=1,2,\dots,a$$

$$n_t \leq \text{Min} \{(M - 1), (a - v)\} \quad \text{For } \forall t \text{ at } v=1,2,\dots,a-1$$

$$X_{i,v} = \{0,1\} \quad \text{For } \forall i, v$$

The objective of this formulated model is to look for the row arrangement of machines in the final matrix which is maximized the sum of the similarity measure between the pair of machines taken up two consecutive rows. The first constraint is restricted a machine to takes up exactly one row in the final matrix. The second constraint is restricted the clustering of parts via computing the machines in final matrix, not to more than maximum cell size limit. The third constraint is restricted the variable as binary variable.

Since the problem is NP-hard, heuristic algorithms are more effective in solving realistic problems. The stages of the algorithm are given as follows.

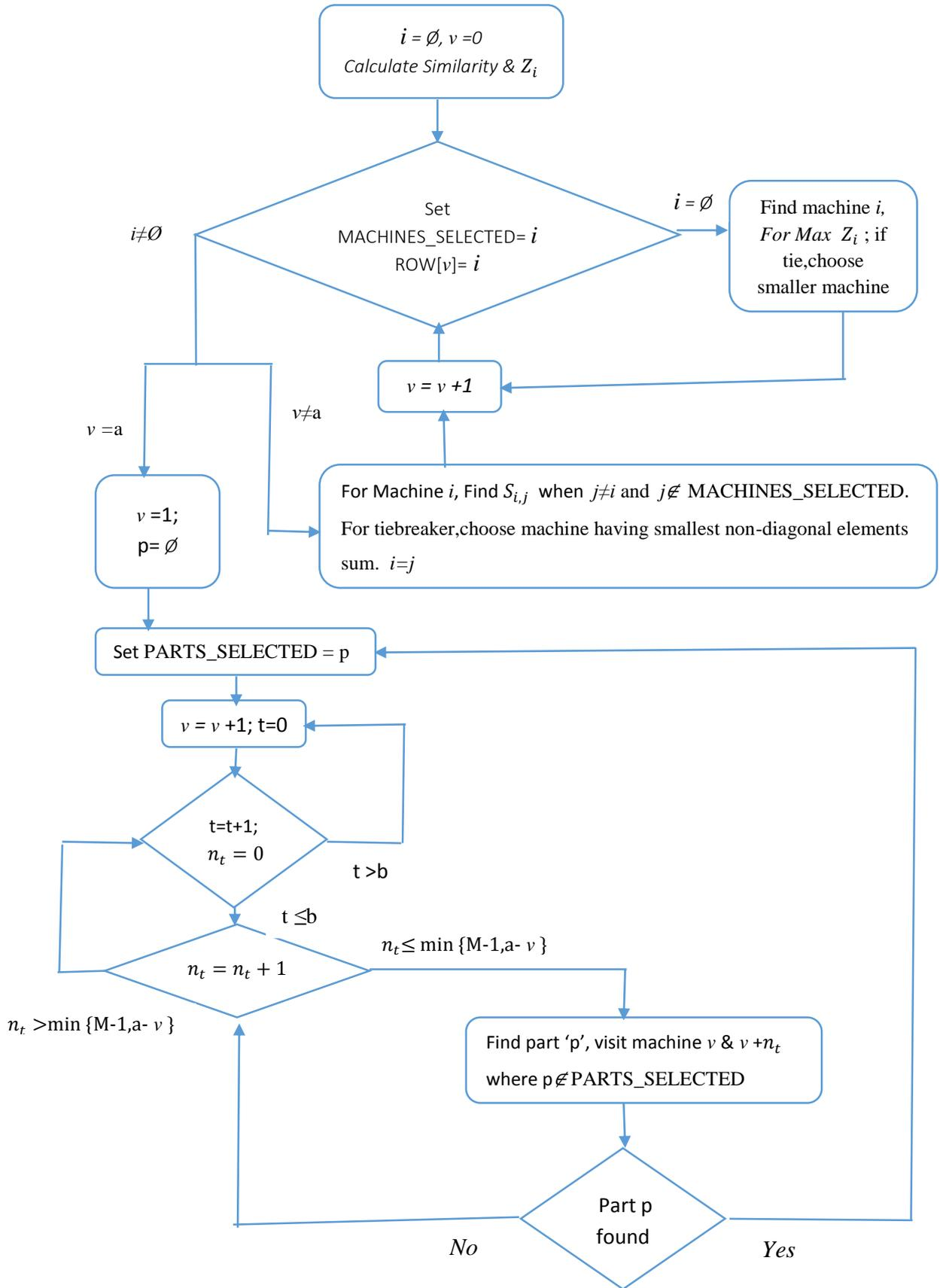

Fig. 3-1 Flow chart of the Proposed Algorithm

Stage 1:

Step 0: Set MACHINES_SELECTED= \emptyset .

Step 1: Calculate Matrix B.

Step 2: For each machine of matrix B, calculate all non-diagonal elements sum,

$$Z_i(i=1,2,\dots,a)$$

Step 3: Find a machine that has the maximum sum of non-diagonal elements of matrix B. If ties, then broken by choosing smallest machine number.

Let this machine be i . Enter machine i into MACHINES_SELECTED.

Step 4: Set v to 1;

Step 5: Set ROW [v] to have machine i .

Step 6: If $v=a$ then go to step 11.

Step 7: For machine i , find from all machines which have the maximum $S_{i,j}$ in matrix B, where $j \neq i$ and $j \notin$ MACHINES_SELECTED. Enter machine j found into MACHINES_SELECTED. For tiebreaker, choose machine having smallest non-diagonal elements sum.

$$i=j$$

Step 8: Increment v by 1.

Step 9: Go to Step 5.

Step 10: Rearrange the rows of matrix A by the order specified in ROW [v]

where $v=1,\dots,a$ and name this matrix B.

Stage 2:

Step 0: Set PARTS_SELECTED= \emptyset .

Step 1: Set v to 1

Set p to 1

Step 2: $v < a$, if not go to step 5,

Step 3: For each part $t=1,2,\dots,b$ and $t \notin \text{PARTS_SELECTED}$

Find part t visit both machines v and $v+n_t$, where $n_t=1,2,\dots,\text{minimum}\{(M-1),(a-v)\}$

Set COL [p] to have part

Enter part t into PARTS_SELECTED

Increment P by 1

Step 4: Increment v by 1, go to step 2

Step 5: Rearrange the column of matrix B by the order specified in COL [p]

where $p=1,\dots,b$.

3.2.3. Performance measure:

Grouping efficiency is first proposed by Chandrasekharan and Rajagopalan[55] as a measure of goodness of a solution. it's stated that 'goodness' of the solution depends on two components; intercell moves(minimize intercell travel) and within group utilization(minimize voids) . Therefore,grouping efficiency is the weighted average of these two components.

Grouping efficiency

$$\eta = q\eta_1 + (1 - q) \eta_2$$

where

q Weighting factor

η_1 Group technology efficiency

$$= \frac{U}{I}$$

η_2 Within group utilization efficiency

$$= \frac{\sum_{r=1}^c m_r p_r - e_0}{\sum_{r=1}^c m_r p_r}$$

Chapter 4

ANALYSIS AND RESULT

Six examples are confronted below for validating the proposed methodology. These examples are considered from the literature addressing operation sequence and weighted data input. The size of these examples is assumed to be equal to the product of $a \times b$ where 'a' and 'b' are denoted the number of machines and the number of parts, respectively. These examples are sorted by their size. Assuming weighting factor q is 0.7 i.e. intercell moves criteria is concerned more over group utilization criteria.

To demonstrate the implementation of proposed “modified close neighbour algorithm”, the first example is considered from Nair and Narendran[21], having a size of 8×20 , shown in Table 1. The maximum four ($M=4$) machines per cell are fixed. Matrix B is given in table 2 formed by equation 1, along with Z_i for each row i . Table 3 is demonstrated the yielding of the intermediate matrix, shown in table 4. In continuation, table 5 is demonstrated the stage 2 so that it's generated the intermediate matrix to a well structured final matrix. The final solution matrix (Table 6) deduces 3 cells with 17 intercell moves and 1 void.

Table 4-1.
Machine-part matrix- Example 1 (initial matrix)

| | | Part | | | | | | | | | | | | | | | | | | | |
|---------|---|------|---|---|---|---|---|---|---|---|----|----|----|----|----|----|----|----|----|----|----|
| | | 1 | 2 | 3 | 4 | 5 | 6 | 7 | 8 | 9 | 10 | 11 | 12 | 13 | 14 | 15 | 16 | 17 | 18 | 19 | 20 |
| Machine | 1 | 1 | 2 | | | | | 1 | 1 | | 3 | | 1 | 1 | | 1 | 3 | | 1 | | |
| | 2 | | | 1 | 1 | | 1 | 4 | | | | | | | 2 | | | | 2 | | 2 |
| | 3 | | 2 | | | | | | 2 | 3 | | 2 | | 2 | 3 | | 2 | 1 | | 2 | |
| | 4 | | | 5 | 2 | | 2 | 2 | | | 2 | | | | | 1 | | | 1 | | 1 |
| | 5 | 2 | | | | 2 | 5 | | | | 3 | | 1 | | | 2 | | 2 | | | |
| | 6 | 1 | | | | 1 | | | | 2 | 1 | | 3 | | | | | | | | 3 |
| | 7 | | | 3 | 3 | | 3 | 3 | | | | 1 | 2 | | | | | | 4 | | 4 |
| | 8 | | | 4 | 4 | | 4 | 1 | | | | | | | | | | | 3 | | 5 |
| Weight | | 1 | 1 | 1 | 1 | 1 | 1 | 1 | 1 | 1 | 1 | 1 | 1 | 1 | 1 | 1 | 1 | 1 | 1 | 1 | 1 |

$$S_{i,j} = \frac{\sum_{t=1}^b w_t (\sum_{p=1}^{P_i} d_{itp} + \sum_{p=1}^{P_j} d_{jtp})}{\sum_{t=1}^b w_t (\sum_{p=1}^{P_i} e_{itp} + \sum_{p=1}^{P_j} e_{jtp})}$$

$$S_{1,2} = \frac{\sum_{t=1}^{20} w_t (\sum_{p=1}^{P_i} d_{itp} + \sum_{p=1}^{P_j} d_{jtp})}{\sum_{t=1}^{20} w_t (\sum_{p=1}^{P_i} e_{itp} + \sum_{p=1}^{P_j} e_{jtp})}$$

$$= \frac{1 \cdot \{0+0+(1+2)+0+0+0+0+0+0+0+0+0+0+(1+2)+0+0+0+0+0+0\}}{1 \cdot \{0+1+(1+2)+1+0+1+1+1+1+1+0+1+(1+2)+0+1+1+2+1+2\}}$$

$$= 0.2857$$

$$S_{1,3} = \frac{\sum_{t=1}^{20} w_t (\sum_{p=1}^{P_i} d_{itp} + \sum_{p=1}^{P_j} d_{jtp})}{\sum_{t=1}^{20} w_t (\sum_{p=1}^{P_i} e_{itp} + \sum_{p=1}^{P_j} e_{jtp})}$$

$$= \frac{1 \cdot \{0+(1+1)+0+0+0+0+0+(1+1)+(1+1)+0+(1+2)+0+(1+1)+(1+1)+0+(1+1)+(1+1)+0+(1+1)+0\}}{1 \cdot \{0+(1+1)+(0+2)+0+0+0+0+(1+1)+(1+1)+0+(1+2)+0+(1+1)+(1+1)+0+(1+1)+(1+1)+0+(1+1)+0\}}$$

$$= 0.90$$

So on...

Table 4-2.
Matrix B

| | | Machine | | | | | | | | Z_i |
|---------|---|---------|--------|------|-------|------|------|------|-------|-------|
| | | 1 | 2 | 3 | 4 | 5 | 6 | 7 | 8 | |
| Machine | 1 | 0.2857 | 0.9 | 0.13 | 0.16 | 0.16 | 0.24 | 0.2 | 2.077 | |
| | 2 | 0.2857 | | 0.2 | 0.773 | 0.11 | 0.22 | 0.79 | 0.895 | 3.228 |
| | 3 | 0.9048 | 0.15 | | 0 | 0.17 | 0.17 | 0.13 | 0 | 1.513 |
| | 4 | 0.1304 | 0.7727 | 0 | | 0.4 | 0.3 | 0.77 | 0.857 | 3.23 |
| | 5 | 0.1579 | 0.1111 | 0.2 | 0.4 | | 0.5 | 0.27 | 0.176 | 1.785 |
| | 6 | 0.1579 | 0.2222 | 0.2 | 0.3 | 0.5 | | 0.32 | 0.176 | 1.841 |
| | 7 | 0.24 | 0.7917 | 0.1 | 0.769 | 0.27 | 0.32 | | 0.87 | 3.386 |
| | 8 | 0.2 | 0.8947 | 0 | 0.857 | 0.18 | 0.18 | 0.87 | | 3.174 |

Table 4-3.
Machine clustering in stage 1.

| Row Index | Machines Set | MACHINES_SELECTED | Explanations |
|-----------|--------------|-------------------|----------------------|
| v=1 | 7 | 7 | Z_7 is maximum |
| v=2 | 8 | 8 | $S_{7,8}$ is maximum |
| v=3 | 2 | 2 | $S_{8,2}$ is maximum |
| v=4 | 4 | 4 | $S_{2,4}$ is maximum |
| v=5 | 5 | 5 | $S_{4,5}$ is maximum |
| v=6 | 6 | 6 | $S_{5,6}$ is maximum |
| v=7 | 3 | 3 | $S_{6,3}$ is maximum |
| v=8 | 1 | 1 | $S_{3,1}$ is maximum |

Table 4-4.
The intermediate matrix from stage 1

| | | Part | | | | | | | | | | | | | | | | | | | | |
|---------|---|------|---|---|---|---|---|---|---|---|----|----|----|----|----|----|----|----|----|----|----|---|
| | | 1 | 2 | 3 | 4 | 5 | 6 | 7 | 8 | 9 | 10 | 11 | 12 | 13 | 14 | 15 | 16 | 17 | 18 | 19 | 20 | |
| Machine | 7 | | | 3 | 3 | | 3 | 3 | | | | 1 | 2 | | | | | | 4 | | 4 | |
| | 8 | | | 4 | 4 | | 4 | 1 | | | | | | | | | | | 3 | | 5 | |
| | 2 | | | 1 | 1 | | 1 | 4 | | | | | | | 2 | | | | 2 | | 2 | |
| | 4 | | | 5 | 2 | | 2 | 2 | | | 2 | | | | | 1 | | | 1 | | 1 | |
| | 5 | 2 | | | | 2 | 5 | | | | 3 | | 1 | | | 2 | | 2 | | | | |
| | 6 | 1 | | | | 1 | | | | 2 | 1 | | 3 | | | | | | | | | 3 |
| | 3 | | 2 | | | | | | 2 | 3 | | 2 | | 2 | 3 | | 2 | 1 | | | 2 | |
| | 1 | | 1 | 2 | | | | | 1 | 1 | | 3 | | 1 | 1 | | 1 | 3 | | | 1 | |

Table 4-5.
Clustering parts in stage 2

| Row Index | Part Set | PARTS_SELECTED | Explanations |
|-----------|--------------------------|--------------------|--|
| v=1 | 1-20 | 3,4,6,7,18,20 | part visit machine v=1 to v=4 (let $r_j=4$) |
| v=4 | 1,2,5,8-17,19 | 10,15 | part visit machine v=4 to v=8 |
| v=5 | 1,2,5,8,9,11-14,16,17,19 | 1,5,12,17 | part visit machine v=5 to v=8 |
| v=6 | 2,8,9,11,13,14,16,19 | 9 | part visit machine v=6 to v=8 |
| v=7 | 2,8,11,13,14,16,19 | 2,8,11,13,14,16,19 | part visit machine v=7 to v=8 |

Table 4-6.
The Final solution matrix

| | | Part | | | | | | | | | | | | | | | | | | | | |
|---------|---|------|---|---|---|----|----|----|----|---|---|----|----|---|---|---|----|----|----|----|----|---|
| | | 3 | 4 | 6 | 7 | 18 | 20 | 10 | 15 | 1 | 5 | 12 | 17 | 9 | 2 | 8 | 11 | 13 | 14 | 16 | 19 | |
| Machine | 7 | 3 | 3 | 3 | 3 | 4 | 4 | | | | | 2 | | | | | 1 | | | | | |
| | 8 | 4 | 4 | 4 | 1 | 3 | 5 | | | | | | | | | | | | | | | |
| | 2 | 1 | 1 | 1 | 4 | 2 | 2 | | | | | | | | | | | | 2 | | | |
| | 4 | 5 | 2 | 2 | 2 | 1 | 1 | 2 | 1 | | | | | | | | | | | | | |
| | 5 | | | 5 | | | | 3 | 2 | 2 | 2 | 1 | 2 | | | | | | | | | |
| | 6 | | | | | | 3 | 1 | | 1 | 1 | 3 | | 2 | | | | | | | | |
| | 3 | | | | | | | | | | | | | | 1 | 3 | 2 | 2 | 2 | 3 | 2 | 2 |
| | 1 | 2 | | | | | | | | | | | | | 3 | 1 | 1 | 1 | 3 | 1 | 1 | 1 |

From table 6,

$$\begin{aligned}
 I &= \sum_{t=1}^{20} (r_t - 1) \\
 &= (1)+(1)+(4)+(3)+(1)+(4)+(3)+(1)+(2)+(2)+(2)+(2) \\
 &\quad +(1)+(2)+(1)+(1)+(2)+(3)+(1)+(4) \\
 &= 41
 \end{aligned}$$

$$\begin{aligned}
 U &= \sum_{t=1}^{20} \sum_{k=1}^{r_t-1} x_{tk} \\
 &= (1)+(1)+(2) + (3) + (1) + (3) + (3) + (1) + (0) + (0) + (1) + (0) + (1) \\
 &\quad + (0) + (0) + (1) + (0) + (3) + (1) + (2) \\
 &= 24
 \end{aligned}$$

$$m_1 p_1 = 4 * 6 = 24$$

$$m_2 p_2 = 2 * 5 = 10$$

$$m_3 p_3 = 2 * 9 = 18$$

$$e_0 = 1$$

From above discription ,

$$\begin{aligned}
 \eta_1 &= \frac{U}{I} \\
 &= \frac{24}{41} \\
 &= 0.5854
 \end{aligned}$$

$$\begin{aligned}
 \eta_2 &= \frac{\sum_{r=1}^3 m_r p_r - e_0}{\sum_{r=1}^3 m_r p_r} \\
 &= \frac{(24+10+18)-1}{(24+10+18)} \\
 &= 0.9808
 \end{aligned}$$

Grouping efficiency

$$\begin{aligned}
 \eta &= q\eta_1 + (1 - q)\eta_2 \\
 &= 0.5854 * 0.7 + 0.9808 * 0.3
 \end{aligned}$$

$$= 0.7040$$

The grouping efficiency for this solution is 70.39% which is same as given by Nair and Narendran[21],but it's far better than A.Ahi[29](68.09%).

The second example is considered from Vakharia et al.[57],having a size of 12x19 shown in table 7. Here machines are revisited by the parts, i.e. any machine may be visited more than one time in order to complete the part. The maximum four(M=4) machines per cell are fixed. The results come out by applying proposed method in final solution matrix (table 8) are as followed: 22 intercell moves and 24 voids, 19 machines are classified into 3 cells.

Table 4-7.
Machine-part incidence matrix- Example 2

| | | Machine | | | | | | | | | | | | Wt | | |
|-------|----|---------|---|---|-----|---|---|-----|---|---|----|----|-----|----|---|---|
| | | 1 | 2 | 3 | 4 | 5 | 6 | 7 | 8 | 9 | 10 | 11 | 12 | | | |
| Parts | 1 | 1 | | | 2 | | | | 3 | 4 | | | | | | 2 |
| | 2 | 1 | | | 2,4 | | | 3,6 | 5 | | | | | | | 3 |
| | 3 | 1 | 2 | | 3 | | | 4 | 5 | 6 | | | | | | 1 |
| | 4 | 1 | | | 2 | | | 3 | | 4 | | | | | | 3 |
| | 5 | 1 | | | | | | 2 | 4 | | 5 | 3 | | | | 2 |
| | 6 | | | | | | | 1 | 3 | 4 | 5 | 2 | | | | 1 |
| | 7 | | | | 2 | | | 1 | | 3 | 4 | | | | | 2 |
| | 8 | | 3 | 1 | 5 | 2 | | 4 | | 6 | 7 | | | | | 1 |
| | 9 | | | 1 | 4 | 2 | | 3 | | 5 | 6 | | | | | 1 |
| | 10 | | | | 1,3 | | | | 2 | 4 | | | | | | 2 |
| | 11 | | | | | | | 1 | | | | | | | | 3 |
| | 12 | | | | | | | | 2 | | | | 1 | 3 | | 1 |
| | 13 | | | | | | | | | | | | 1 | 2 | | 1 |
| | 14 | | | | | | | | 2 | | | 3 | 1 | | | 3 |
| | 15 | 1 | | | | | | | 2 | | | 4 | 3,5 | 6 | | 1 |
| | 16 | 1 | | | | | | | 2 | | | 4 | 3,5 | 6 | | 2 |
| | 17 | | | | | | | | 2 | | | | 1 | 3 | | 1 |
| | 18 | | | | | | | 1 | 2 | | | 3 | | | | 3 |
| | 19 | | | | | | | | | | | | | | 1 | 2 |

$$I = \sum_{t=1}^{19} (r_t - 1) = 55$$

$$U = \sum_{t=1}^{19} \sum_{k=1}^{r_t-1} x_{tk} = 33$$

$$\sum_{r=1}^3 m_r p_r = 40+32+4 = 76$$

$$e_0 = 24$$

From above discription ,

$$\begin{aligned} \eta_1 &= \frac{U}{I} \\ &= \frac{38}{60} \\ &= 0.6333 \end{aligned}$$

$$\begin{aligned} \eta_2 &= \frac{\sum_{r=1}^3 m_r p_r - e_0}{\sum_{r=1}^3 m_r p_r} \\ &= \frac{76-24}{76} \\ &= 0.6842 \end{aligned}$$

Grouping efficiency

$$\begin{aligned} \eta &= q\eta_1 + (1 - q)\eta_2 \\ &= 0.6486 \end{aligned}$$

The grouping efficiency for this solution is 64.86% which in compare with Atif et. al.[58](59.38%) is far better and shows less intercell moves with zero exceptional part.

Table 4-8.
The Final solution matrix- Example 2

| | | Machine | | | | | | | | | | | | | | | | | |
|-------|----|---------|---|-----|---|-----|----|-----|----|---|---|---|---|--|--|--|--|---|---|
| | | 9 | 8 | 4 | 1 | 7 | 10 | 11 | 12 | 6 | 5 | 3 | 2 | | | | | | |
| Parts | 1 | 4 | 3 | 2 | 1 | | | | | | | | | | | | | | |
| | 3 | 6 | 5 | 3 | 1 | 4 | | | | | | | | | | | | 2 | |
| | 4 | 4 | | 2 | 1 | 3 | | | | | | | | | | | | | |
| | 5 | 5 | | | 1 | 4 | 3 | | | | 2 | | | | | | | | |
| | 6 | 5 | 4 | | | 3 | 2 | | | | 1 | | | | | | | | |
| | 7 | 4 | 3 | 2 | | | | | | | 1 | | | | | | | | |
| | 8 | 7 | 6 | 5 | | | | | | | 4 | 2 | 1 | | | | | | 3 |
| | 9 | 6 | 5 | 4 | | | | | | | 3 | 2 | 1 | | | | | | |
| | 2 | | 5 | 2,4 | 1 | 3,6 | | | | | | | | | | | | | |
| | 10 | | 4 | 1,3 | | 2 | | | | | | | | | | | | | |
| | 15 | | | | 1 | 2 | 4 | 3,5 | 6 | | | | | | | | | | |
| | 16 | | | | 1 | 2 | 4 | 3,5 | 6 | | | | | | | | | | |
| | 12 | | | | | 2 | | 1 | 3 | | | | | | | | | | |
| | 14 | | | | | 2 | 3 | 1 | | | | | | | | | | | |
| | 17 | | | | | 2 | | 1 | 3 | | | | | | | | | | |
| | 18 | | | | | 2 | 3 | | | | 1 | | | | | | | | |
| | 13 | | | | | | | 1 | 2 | | | | | | | | | | |
| | 19 | | | | | | | | 1 | | | | | | | | | | |
| | 11 | | | | | | | | | | 1 | | | | | | | | |

The third example is taken from Harhalakis et. al.[56],having a size of 20x20 shown in Table 9. The maximum five(M=5) machines per cell are fixed. In table 10, the solution matrix is splitted the 20 parts into 5 cells, which in result 17 intercell moves and 20 voids. This result is best in its class. For comparative study in terms of grouping efficiency is as followed.

Table 4-9.

Machine-part incidence matrix- Example 3

| | | Machine | | | | | | | | | | | | | | | | | | | W t |
|-------|----|---------|---|---|---|---|---|---|---|---|----|----|----|----|----|----|----|----|----|----|--------|
| | | 1 | 2 | 3 | 4 | 5 | 6 | 7 | 8 | 9 | 10 | 11 | 12 | 13 | 14 | 15 | 16 | 17 | 18 | 19 | |
| Parts | 1 | 2 | | | | | | | 3 | | 1 | | | | | | | 4 | | 5 | 1 |
| | 2 | | 3 | 2 | | | | | | | 1 | | | | | | | | | | 1 |
| | 3 | | | | | | | 1 | | | | | | | | | | | 3 | 2 | 1 |
| | 4 | | 3 | 1 | | | | | | | 4 | 2 | | | | | | | | | 1 |
| | 5 | | | | 1 | | 3 | 4 | | | | | | | 2 | | | | | | 1 |
| | 6 | | | | | 5 | | | | | 1 | | 2 | | 3 | 4 | | | | | 1 |
| | 7 | | | | | 1 | | | | | | | | | 2 | 3 | | | | | 1 |
| | 8 | | | | 5 | | | 3 | 4 | | | | 2 | 1 | | | | | | | 1 |
| | 9 | 4 | | | | | | | | 2 | 3 | 5 | | | | | | | 1 | | 1 |
| | 10 | | | | | | | | 3 | | | | | | | | | | 1 | 2 | 1 |
| | 11 | | | 3 | | | | | | | 1 | | 2 | | | | | | | | 1 |
| | 12 | 5 | | | 3 | | | | 1 | | 4 | | | | | | | 2 | | | 1 |
| | 13 | | | | | 1 | 2 | | | | | | | 3 | 4 | | | | | | 1 |
| | 14 | 3 | 4 | | | | | | 1 | 2 | | | | | | | | | | | 1 |
| | 15 | | | | | | | | | | | 1 | 2 | | 3 | 4 | | | | | 1 |
| | 16 | | | | | 3 | 2 | | | | | | | 1 | | | | | 4 | | 1 |
| | 17 | 2 | | | | | | | | 1 | | 3 | | | | | | | | | 1 |
| | 18 | | | | | | | | 1 | 4 | | | | | | | | | 2 | 3 | 1 |
| | 19 | | 2 | 1 | | 4 | | | | | 3 | | | | | | | | | | 1 |
| | 20 | 3 | | | | | | | | | 2 | 4 | | | | | | | 1 | | 1 |

$$I = \sum_{t=1}^{19} (r_t - 1) = 59$$

$$U = \sum_{t=1}^{19} \sum_{k=1}^{r_t-1} x_{tk} = 42$$

$$\sum_{r=1}^3 m_r p_r = 40+32+4 = 84$$

$$e_0 = 20$$

From above discription ,

$$\begin{aligned} \eta_1 &= \frac{U}{I} \\ &= \frac{42}{59} \\ &= 0.7118 \end{aligned}$$

The fourth example is considered from Su et. al.[59],having a size of 18x35 shown in table 11. Here machines are revisited by the parts. The maximum six(M=6) machines per cell are fixed. After applying proposed method, the final solution matrix in table 12, is splited the 35 parts into 4 different cells, which having 48 intercell moves with 42 voids. In order to compute the grouping efficient, we need following.

$$I = \sum_{t=1}^{35} (r_t - 1) = 140$$

$$U = \sum_{t=1}^{35} \sum_{k=1}^{r_t-1} x_{tk} = 92$$

$$\sum_{r=1}^4 m_r p_r = 40+60+40+21 = 161$$

$$e_0 = 42$$

From above discription ,

$$\begin{aligned} \eta_1 &= \frac{U}{I} \\ &= \frac{92}{140} \\ &= 0.6571 \end{aligned}$$

$$\begin{aligned} \eta_2 &= \frac{\sum_{r=1}^4 m_r p_r - e_0}{\sum_{r=1}^4 m_r p_r} \\ &= \frac{161-42}{161} \\ &= 0.7391 \end{aligned}$$

Grouping efficiency

$$\begin{aligned} \eta &= q\eta_1 + (1 - q)\eta_2 \\ &= 0.6817 \end{aligned}$$

The grouping efficiency for this solution is 68.17% which is in compare with A.Ahi [29] (using TOPSIS-IMP-SAW, 60.68%; using TOPSIS-IMP-TOPSIS,60.42%) and Atif et.al.[58](60.68%) far better than our result.

Table 4-11.

Part-machine incidence matrix- Example 4

| | Machine | | | | | | | | | | | | | | | | | | Wt |
|------|---------|-----|-----|-----|----|-----|-----|-----|-----|-----|-----|----|----|----|-----|-----|----|-----|-----|
| | 1 | 2 | 3 | 4 | 5 | 6 | 7 | 8 | 9 | 10 | 11 | 12 | 13 | 14 | 15 | 16 | 17 | 18 | |
| Part | 1 | | | 2 | | | | | | 6 | | 3 | 5 | | | | | | 1 |
| | 2 | 1,4 | | | | | | 2 | | | | | | | | | | 3 | |
| | 3 | | | | | | | | 2 | | | | 5 | 1 | 4 | | | | |
| | 4 | | | 5 | | | | 3 | | 2 | | | | | | 4 | | | 1 |
| | 5 | 2 | | | | 3 | | | | | | 4 | | | 1 | | | | |
| | 6 | | | | | | 3 | | | 2 | | | | | | 1 | | | |
| | 7 | | | | | | | | | | 1 | | | | | | | 3 | |
| | 8 | | | 2 | | | | | | | | | | | | | | | |
| | 9 | | | 3 | | | | | | 2,5 | | | | | | | 1 | | 4 |
| | 10 | | | | 4 | | 5 | | | | 2,6 | | 1 | | | 3 | | | |
| | 11 | | 2,5 | | | | 4 | | | | | | 3 | 1 | | | | | |
| | 12 | | 2 | | 3 | | 1,5 | | | | | | | | 4 | | | | |
| | 13 | | 2 | | 1 | | 3 | 5 | | | | | 4 | 6 | | | | | |
| | 14 | | | | | | | 2,4 | | | | | | | | 5 | 1 | | 3 |
| | 15 | | | 5 | | | | | 3 | | 1 | | | | | | 6 | | 2,4 |
| | 16 | | | | | | | | 1 | | 4 | | | | | | 3 | | 2 |
| | 17 | 3 | | | | 1,4 | | | | | | 2 | | | | 5 | | | |
| | 18 | 2 | | | 4 | | | | | | | 1 | | | | 3,5 | | | |
| | 19 | | | | | | 3 | | | | 2,4 | | | | | | 1 | | |
| | 20 | 4 | | | | 2 | | | | | | 3 | | | | | 1 | | |
| | 21 | | | | | | | | 1,3 | | | | | | | | | 2 | 4 |
| | 22 | | | | | | 1 | | | 4 | 2,5 | | | | | | 3 | | |
| | 23 | | | 6 | | | | 1 | | | | | | 3 | 2,5 | 4 | | | |
| | 24 | | 3,5 | | 2 | | 1 | | | | | | 4 | 6 | | | | | |
| | 25 | | | | 2, | | 4 | | | | 3 | | 1 | 5 | | | | | |
| | 26 | | | 1,3 | | | | 2 | | | | | | 5 | | | | 4 | |
| | 27 | | | 3 | | | | 1,6 | | | | | | 5 | 2 | | | 4 | |
| | 28 | | | 1 | | | | | 3,6 | | | | | | | 2 | 5 | | 4 |
| | 29 | 2,4 | | | | | | | | | | | 1 | | | | 3 | | |
| | 30 | 1,3 | | | | | | | | | | 4 | | | | | 2 | | |
| | 31 | | | | | | 2 | | | 4 | 1 | | | | | 3 | | 5 | |
| | 32 | | | | | | 5 | | | 3 | 2 | | | | | 1 | | | 4 |
| | 33 | | | 3 | | | | | 5 | | 2,4 | | | | | | 6 | | 1 |
| | 34 | | | | | | | 4,6 | | | | | | 2 | 5 | 3 | | 1 | |
| | 35 | | 1 | | 3 | | | | | | | 5 | | 4 | 2 | | | | |
| | | | 4 | | | | | 3 | | | | | | | 1 | 6 | | 2,5 | |

Table 4-12.
The Final solution matrix- Example 4

| | | Machine | | | | | | | | | | | | | | | | | | |
|-------------|----|---------|-----|----|-----|-----|-----|-----|-----|----|-----|-----|-----|----|-----|---|-----|-----|-----|---|
| | | 13 | 2 | 12 | 4 | 6 | 9 | 15 | 1 | 11 | 5 | 10 | 18 | 16 | 8 | 3 | 17 | 7 | 14 | |
| Part | 1 | 5 | 1,4 | 3 | 2 | | | | | | | 6 | | | | | | | | |
| | 10 | 1 | 2,5 | 3 | | 4 | | | | | | | | | | | | | | |
| | 11 | 4 | 2 | | 3 | 1,5 | | | | | | | | | | | | | | |
| | 12 | 6 | 2 | 4 | 1 | 3 | | | | | | | | | | | | 5 | | |
| | 23 | 6 | 3,5 | 4 | 2 | 1 | | | | | | | | | | | | | | |
| | 24 | 5 | | 1 | 2,6 | 4 | | | | | | 3 | | | | | | | | |
| | 34 | 2 | 1 | 4 | 3 | | | | | | | 5 | | | | | | | | |
| | 9 | | | 1 | 4 | 5 | | 3 | | | | 2,6 | | | | | | | | |
| | 5 | | | | | 3 | 2 | 1 | | | | | | | | | | | | |
| | 18 | | | | | 3 | 2,4 | 1 | | | | | | | | | | | | |
| | 21 | | | | | 1 | 4 | 3 | | | | 2,5 | | | | | | | | |
| | 30 | | | | | 2 | 4 | 3 | | | | 1 | | | | | 5 | | | |
| | 31 | | | | | 5 | 3 | 1 | | | | 2 | 4 | | | | | | | |
| | 6 | | | | | | 1 | 2,4 | | | | 3 | | | | | | | | |
| | 4 | | | | | | | 1 | 2 | 4 | 3 | | | | | | | | | |
| | 16 | | | | | | | 5 | 3 | 2 | 1,4 | | | | | | | | | |
| | 17 | | | | | | | 3,5 | 2 | 1 | 4 | | | | | | | | | |
| | 19 | | | | | | | 1 | 4 | 3 | 2 | | | | | | | | | |
| | 28 | | | | | | | 3 | 2,4 | 1 | | | | | | | | | | |
| | 29 | | | | | | | 2 | 1,3 | 4 | | | | | | | | | | |
| | 3 | | | | | | | | | | | 2 | 1 | 4 | 3 | 5 | | | | |
| | 7 | | | | | | | | | | | 1 | | 3 | | 2 | | | | |
| | 8 | | | | | | | | | | | 2,5 | 4 | 1 | | 3 | | | | |
| | 14 | | | | | | | | | | | 1 | 2,4 | 6 | 3 | 5 | | | | |
| | 15 | | | | | | | | | | | 4 | 2 | 3 | 1 | | | | | |
| | 32 | | | | | | | | | | | 2,4 | 1 | 6 | 5 | 3 | | | | |
| | 20 | | | | | | | | | | | | 4 | 2 | 1,3 | | | | | |
| | 27 | | | | | | | | | | | | 4 | 5 | 3,6 | 1 | | | | |
| | 22 | 3 | | | | | | | | 2 | | | | | | | 6 | 1 | 2,5 | |
| | 25 | 5 | | | | | | | | 4 | | | | | | | 1,3 | 4 | 2 | |
| | 26 | 5 | | | | | | | | | | | | | | | 3 | 4 | 1,6 | 2 |
| | 35 | | | | | | | | | 6 | | | | | | | 4 | 2,5 | 3 | 1 |
| | 2 | 5 | | | | | | | | 4 | | | | | | | | 3 | 2 | 1 |
| 13 | | | | | | | | | 1 | | | | | | | | 3 | 2,4 | 5 | |
| 33 | | | | | | | | | 2 | | | | | | | | 1 | 4,6 | 5 | |
| | | | | | | | | | 3 | | | | | | | | | | | |

The fifth example is considered from Nair and Narendran[21], having a size of 25x40, shown in table 13. The maximum four (M=4) machines per cell are fixed. After applying proposed method, the final solution matrix in table 14, splits the 40 parts into 8 different cells, which having 35 intercell moves with 25 voids. In order to compute the grouping efficient, we need following.

Table 4-13.

Part-machine incidence matrix- Example 5

| | | Machine | | | | | | | | | | | | | | | | | | | | | | | | | Wt | | | |
|------|----|---------|---|---|---|---|---|---|---|---|----|----|----|----|----|----|----|----|----|----|----|----|----|----|----|----|----|---|---|---|
| | | 1 | 2 | 3 | 4 | 5 | 6 | 7 | 8 | 9 | 10 | 11 | 12 | 13 | 14 | 15 | 16 | 17 | 18 | 19 | 20 | 21 | 22 | 23 | 24 | 25 | | | | |
| Part | 1 | | | | 5 | | | 3 | | | 1 | | | | | | 4 | | 2 | | | | | | 6 | | | 1 | | |
| | 2 | 2 | 3 | | | | | | | | | | | | | | 4 | | | | | | | | | | 1 | 1 | | |
| | 3 | | | 2 | | | | | | | | 3 | | | | | | | | | | | | | 1 | | | 1 | | |
| | 4 | | | | | | | | | | | | 1 | | | | | | | | | | | | | | 2 | 1 | | |
| | 5 | | | | 3 | | | | | | | | 2 | | | | | | 1 | | | | | | | | | 1 | | |
| | 6 | | | | | | | | | | | | | 3 | | | | 2 | | | | | | | | 1 | | 1 | | |
| | 7 | | | | | | | 3 | | 2 | | 5 | | | | | | 4 | | 1 | | | | | | | | 1 | | |
| | 8 | | | | | | | | 1 | | | | | | | | | 3 | | | 2 | | | | | | | 1 | | |
| | 9 | | | | 3 | | | | | | | | | 4 | | | | | | | 1 | | | | | | 2 | 1 | | |
| | 10 | | | | | | | | | | 2 | 1 | | | | | | | | | | | | | | | 3 | 1 | | |
| | 11 | | | | | | | | | | | 2 | | | | | 3 | | | | | | | | 1 | | | 1 | | |
| | 12 | 1 | | 4 | | | | | | | | | | | | | | | 3 | | | | | | | | 2 | 5 | 1 | |
| | 13 | | | | 3 | | | | | | | | | | | | | | | | | | | | | | | 1 | 1 | |
| | 14 | | | | 4 | | 1 | | | | | | | | 2 | | | | | | | | | | | | 3 | | 1 | |
| | 15 | | | | | | | | | | | | | | | | 5 | | | | | | | | | | | 1 | 1 | |
| | 16 | | | | 4 | | | | | | | | | | | | | | 1 | | | | | | | 2 | | 1 | 1 | |
| | 17 | | | | | | | | 1 | | | | | | | | | | 2 | | | | | | | | | 4 | 1 | |
| | 18 | | | | | | | | | 1 | | | | | | | | | | | | | | | | | | 2 | 1 | 1 |
| | 19 | | | | | | | | | | | | | | | | | | | | | | | | | | | | 1 | 1 |
| | 20 | | | | | | | | | | | | | | | | | | | | | | | | | | | | 1 | 1 |
| | 21 | | | | | | | | | | | | | | | | | | | | | | | | | | | | 1 | 1 |
| | 22 | | | | | | | | | | | | | | | | | | | | | | | | | | | | 1 | 1 |
| | 23 | | | | | | | | | | | | | | | | | | | | | | | | | | | | 1 | 1 |
| | 24 | | | | | | | | | | | | | | | | | | | | | | | | | | | | 1 | 1 |
| | 25 | | | | | | | | | | | | | | | | | | | | | | | | | | | | 1 | 1 |
| | 26 | | | | | | | | | | | | | | | | | | | | | | | | | | | | 1 | 1 |
| | 27 | | | | | | | | | | | | | | | | | | | | | | | | | | | | 1 | 1 |
| | 28 | | | | | | | | | | | | | | | | | | | | | | | | | | | | 1 | 1 |
| | 29 | | | | | | | | | | | | | | | | | | | | | | | | | | | | 1 | 1 |
| | 30 | | | | | | | | | | | | | | | | | | | | | | | | | | | | 1 | 1 |
| | 31 | | | | | | | | | | | | | | | | | | | | | | | | | | | | 1 | 1 |
| | 32 | | | | | | | | | | | | | | | | | | | | | | | | | | | | 1 | 1 |
| | 33 | | | | | | | | | | | | | | | | | | | | | | | | | | | | 1 | 1 |
| | 34 | | | | | | | | | | | | | | | | | | | | | | | | | | | | 1 | 1 |
| | 35 | | | | | | | | | | | | | | | | | | | | | | | | | | | | 1 | 1 |
| | 36 | | | | | | | | | | | | | | | | | | | | | | | | | | | | 1 | 1 |
| | 37 | | | | | | | | | | | | | | | | | | | | | | | | | | | | 1 | 1 |
| | 38 | | | | | | | | | | | | | | | | | | | | | | | | | | | | 1 | 1 |
| | 39 | | | | | | | | | | | | | | | | | | | | | | | | | | | | 1 | 1 |
| | 40 | | | | | | | | | | | | | | | | | | | | | | | | | | | | 1 | 1 |

Table 4-14.
The Final solution matrix- Example 5

| | | Machine | | | | | | | | | | | | | | | | | | | | | | | | | |
|------|----|---------|---|--------|---|--------|---|---|--------|--------|--------|--------|--------|---|---|--------|--------|--------|---|--------|---|--------|--------|--------|--------|--------|---|
| | | 1 6 | 7 | 1 8 | 4 | 1 0 | 9 | 8 | 1 3 | 1 4 | 1 5 | 2 2 | 2 1 | 6 | 5 | 1 9 | 2 2 | 1 1 | 7 | 2 4 | 3 | 2 0 | 1 1 | 2 5 | 1 2 | 2 3 | |
| Part | 1 | 4 | 3 | 2 | 5 | 1 | | | | | | | | 6 | | | | | | | | | | | | | |
| | 7 | 4 | 2 | 1 | 3 | 5 | | | | | | | | | | | | | | | | | | | | | |
| | 16 | 2 | 3 | 4 | 1 | | | | | | | | | | | | | | | | | | | | | | |
| | 30 | 3 | 2 | 1 | 4 | | | | | | | | | | | | | | | | | | | | | | |
| | 17 | | 1 | 2 | | 3 | | | | | | | | | | | | | | | | | | | | | |
| | 5 | | | 1 | 3 | | | | | | | | | | | | | | | | | | | | | | 2 |
| | 19 | | | | | 2 | 3 | 1 | | | | | | | | | | | | | | | | | | | |
| | 21 | | | | | 2 | 3 | 1 | | | | | | | | | | | | | | | | | | | |
| | 28 | | | | | 3 | 1 | 2 | | | | | | | | | | | | | | | | | | | |
| | 10 | | | | | | 1 | 2 | | | | | | | | | | | | | | | | | | 3 | |
| | 22 | | | | | | 2 | 4 | | | | | | | | | 1 | | | | 3 | | | | | | |
| | 38 | | | | | | 3 | 2 | | | | | | | 1 | | | | | | | | | | | | |
| | 11 | | | | | | | 2 | 3 | | | | | | | 1 | | | | | | | | | | | |
| | 32 | | | | | | | | 2 | 1 | 3 | 4 | | | | | | | | | | | | | | | |
| | 18 | | | | | | | | | 3 | 2 | 1 | | | | | | | | | | | | | | | |
| | 25 | | | | | | | | | | 3 | 2 | 1 | | | | | | | | | | | | | | |
| | 35 | | | | | | | | | | 4 | 3 | 1 | 2 | | | | | | | | | | | | | |
| | 40 | | | | | | | | | | 3 | | 1 | 2 | | | | | | | | | | | | | |
| | 27 | | | | | | | | | | | 2 | 3 | | | | | | | | | | | | | | 1 |
| | 29 | | | | | | | | | | | 1 | 2 | | 3 | | | | | | | | | | | | |
| 8 | 3 | | | | | | | | | | | | | | 1 | 2 | | | | | | | | | | | |
| 15 | 1 | | | 5 | | | | | | | | | | | 3 | 2 | 4 | | | | | | | | | | |
| 23 | 3 | | | | | | | | | | | | | | | 2 | 1 | | | | | | | | | | |
| 24 | 2 | | | | | | | | | | | | | | | 1 | | | | | | | | | | | |
| 31 | | | | | | | | | | | | | | | | 2 | 3 | | | | | | | | | | |
| 2 | | | | | | | | | | | | | | | | | | | | | | | | | | | |
| 36 | | | | | | | | | | | | | | | | | | | | | | | | | | 1 | |
| 12 | | | | | | | | | | | | | | | | | | | | | | | | | 4 | | |
| 3 | | | | | | | | | | | | | | | | | | | | | | | | | | 5 | |
| 9 | | | | | | | | | | | | | | | | | | | | | | | | | | | |
| 13 | | | | | | | | | | | | | | | | | | | | | | | | | | | |
| 14 | | | | | | | | | | | | | | | | | | | | | | | | | | | |
| 33 | | | | | | | | | | | | | | 1 | | | | | | | | | | | | | |
| 4 | | | | | | | | | | | | | | | | | | | | | | | | | | 1 2 | |
| 6 | 2 | | | | | | | | | | | | | | | | | | | | | | | | | 3 1 | |
| 26 | | | | 2 | | | | | | | 4 | | | | | | | | | | | | | | | 3 1 | |
| 34 | | | | | | | | | | | | | | | | | | | | | | | | | | 2 1 | |
| 37 | | | | | | | | | | | | | | | | | | | | | | | | | | 2 1 | |
| 39 | | | | 3 | | | | | | | | | | | | | | | | | | | | | | 1 | |
| 20 | | | | | | | | | | | | | | | | | | | | | | | | | | 1 | |

$$I = \sum_{t=1}^{40} (r_t - 1) = 93$$

$$U = \sum_{t=1}^{40} \sum_{k=1}^{r_t-1} x_{tk} = 58$$

$$\sum_{r=1}^8 m_r p_r = 24+18+6+20+10+12+20+14 = 124$$

$$e_0 = 25$$

From above discription ,

$$\begin{aligned} \eta_1 &= \frac{U}{I} \\ &= \frac{58}{93} \\ &= 0.6236 \end{aligned}$$

$$\begin{aligned} \eta_2 &= \frac{\sum_{r=1}^8 m_r p_r - e_0}{\sum_{r=1}^8 m_r p_r} \\ &= \frac{124-25}{124} \\ &= 0.7984 \end{aligned}$$

Grouping efficiency

$$\begin{aligned} \eta &= q\eta_1 + (1 - q)\eta_2 \\ &= 0.6760 \end{aligned}$$

The grouping efficiency for this solution is 67.60% which is far better than Nair and Narendran[21](67.06%), Atif et.al.[58](63.75%), A.Ahi[29](using TOPSIS-IMP-SAW,49.39%;using TOPSIS-IMP-TOPSIS,40.05%).

While **the sixth example** is taken from Atif et.al.[58],having a size of 20x51,shown in table 15. The maximum five(M=5) machines per cell are fixed. The final solution matrix is given in table 16, splited the 51 parts into 5 different machine-cells. The results are deduced from table 16, are 45 intercell moves and 66 voids. In order to compute the result, the grouping efficiency is as followed.

Table 4-15.
Part-machine incidence matrix- Example 6

| | Machine | | | | | | | | | | | | | | | | | | | | Wt | |
|------|---------|---|---|---|---|---|---|---|---|----|----|----|----|----|----|----|----|----|----|----|----|---|
| | 1 | 2 | 3 | 4 | 5 | 6 | 7 | 8 | 9 | 10 | 11 | 12 | 13 | 14 | 15 | 16 | 17 | 18 | 19 | 20 | | |
| Part | 1 | | | | | 3 | | | 2 | | | 1 | | | | | | | | | 2 | |
| | 2 | | | | | | 3 | | 2 | | | 1 | | | | | | | | | 2 | |
| | 3 | 3 | | | | 1 | | | | | | 2 | | | | | | | | | 2 | |
| | 4 | 3 | | | | | 1 | | | | | 2 | | | | | | | | | 2 | |
| | 5 | 1 | | | | | | 4 | | 2 | | 3 | | | | | | | | | 2 | |
| | 6 | 1 | | | | | 4 | | | 2 | | 3 | | | | | | | | | 2 | |
| | 7 | 1 | | | | | 3 | | | | | 2 | | | | | | | | | 2 | |
| | 8 | 1 | | | | | | 3 | | | | 2 | | | | | | | | | 2 | |
| | 9 | 2 | | | | | | | | 1 | | 3 | | | | | | | | 4 | 2 | |
| | 10 | 2 | | | | | | | | | 1 | 3 | | | | | | | 4 | | 2 | |
| | 11 | 2 | | | | | | | | | 1 | 3 | | | | | | | | | 4 | 2 |
| | 12 | | 3 | | | | 2 | 1 | | | | | | | | | | | | | | 2 |
| | 13 | | 3 | | | | 2 | | 1 | | | | | | | | | | | | | 2 |
| | 14 | | | | | | 1 | | 4 | | | | | | | | 2 | | | 3 | | 2 |
| | 15 | | | | | | 1 | | 4 | | | | | | | | 2 | | 3 | | | 2 |
| | 16 | | | | | | 1 | | 4 | | | | | | | | 2 | | | | 3 | 2 |
| | 17 | | | | | | 1 | 4 | | | | | | | | | 2 | | | 3 | | 2 |
| | 18 | | | | | | 1 | 4 | | | | | | | | | 2 | | 3 | | | 2 |
| | 19 | | | | | | 1 | 4 | | | | | | | | | 2 | | | | 3 | 2 |
| | 20 | | 3 | | | | | | 2 | | | | | | | | 1 | | | | | 2 |
| | 21 | | 3 | | | | | 2 | | | | | | | | | 1 | | | | | 2 |
| | 22 | | 2 | | | | | | 4 | | | | | | | | 1 | | | 3 | | 1 |
| | 23 | | 2 | | | | | 4 | | | | | | | | | 1 | | | 3 | | 1 |
| | 24 | | 2 | | | | | | 4 | | | | | | | | 1 | | 3 | | | 1 |
| | 25 | | 2 | | | | | 4 | | | | | | | | | 1 | | 3 | | | 1 |
| | 25 | | 2 | | | | | | 4 | | | | | | | | 1 | | | | 3 | 1 |
| | 27 | | 2 | | | | | | 4 | | | | | | | | 1 | | | | 3 | 1 |
| | 28 | | 1 | | | | 3 | 4 | | | | | | | | | 2 | | | | | 3 |
| | 29 | | 1 | | | | 3 | | 4 | | | | | | | | 2 | | | | | 3 |
| | 30 | | | 2 | | | | | | 1 | | | 3 | | | | | | | 4 | | 3 |
| | 31 | | | 2 | | | | | | | 1 | | 3 | | | | | | | 4 | | 5 |
| | 32 | | | 2 | | | | | | | 1 | | 3 | | | | | | | | 4 | 3 |
| | 33 | | | 1 | | | | | | | 2 | | | | | | | | | 3 | | 3 |
| | 34 | | | 1 | | | | | | | 2 | | | | | | | | | | 3 | 3 |
| | 35 | | | 1 | | | | | | | 2 | | | | | | | | | | 3 | 3 |
| | 36 | | | 3 | | | | | | | 2 | | 1 | | | | | | | 4 | | 4 |
| | 37 | | | 3 | | | | | | | 2 | | 1 | | | | | | | 4 | | 4 |
| | 38 | | | 3 | | | | | | | 2 | | 1 | | | | | | | | 4 | 4 |
| | 39 | | | | | | | | | | | 1 | | | 3 | | | 4 | 2 | | | 2 |
| | 40 | | | | | | | | | | | 1 | | | 3 | | | 4 | | 2 | | 2 |
| | 41 | | | | | | | | | | | 1 | | | 3 | | | 4 | | 2 | | 2 |

Table 4-16.
The Final solution matrix- Example 6

| | | Machine | | | | | | | | | | | | | | | | | | |
|------|----|---------|---|---|---|----|---|---|---|----|---|---|----|----|----|----|----|----|---|----|
| | | 16 | 5 | 2 | 6 | 12 | 1 | 9 | 7 | 18 | 8 | 3 | 11 | 19 | 10 | 14 | 17 | 20 | 4 | 15 |
| Part | 14 | 2 | 1 | | | | | | 4 | | | | | 3 | | | | | | |
| | 15 | 2 | 1 | | | | | | 4 | 3 | | | | | | | | | | |
| | 16 | 2 | 1 | | | | | | 4 | | | | | | | | | 3 | | |
| | 17 | 2 | 1 | | 4 | | | | | | | | | 3 | | | | | | |
| | 18 | 2 | 1 | | 4 | | | | | 3 | | | | | | | | | | |
| | 19 | 2 | 1 | | 4 | | | | | | | | | | | | | | 3 | |
| | 20 | 1 | | 3 | | | | | 2 | | | | | | | | | | | |
| | 21 | 1 | | 3 | 2 | | | | | | | | | | | | | | | |
| | 22 | 1 | | 2 | | | | | 4 | | | | | 3 | | | | | | |
| | 23 | 1 | | 2 | 4 | | | | | | | | | 3 | | | | | | |
| | 24 | 1 | | 2 | | | | | 4 | 3 | | | | | | | | | | |
| | 25 | 1 | | 2 | 4 | | | | | 3 | | | | | | | | | | |
| | 26 | 1 | | 2 | | | | | 4 | | | | | | | | | | | 3 |
| | 27 | 1 | | 2 | 4 | | | | | | | | | | | | | | | 3 |
| | 28 | 2 | 3 | 1 | 4 | | | | | | | | | | | | | | | |
| | 29 | 2 | 3 | 1 | | | | | 4 | | | | | | | | | | | |
| | 12 | | | 2 | 3 | 1 | | | | | | | | | | | | | | |
| | 13 | | | 2 | 3 | | | | | 1 | | | | | | | | | | |
| | 1 | | | | | 3 | 1 | | 2 | | | | | | | | | | | |
| | 3 | | | | | 1 | 2 | 3 | | | | | | | | | | | | |
| | 6 | | | | | 4 | 3 | 1 | 2 | | | | | | | | | | | |
| | 7 | | | | | 3 | 2 | 1 | | | | | | | | | | | | |
| | 2 | | | | | | 1 | | 2 | 3 | | | | | | | | | | |
| | 4 | | | | | | 2 | 3 | | 1 | | | | | | | | | | |
| | 5 | | | | | | 3 | 1 | 2 | 4 | | | | | | | | | | |
| | 8 | | | | | | 2 | 1 | | 3 | | | | | | | | | | |
| | 9 | | | | | | 3 | 2 | 1 | | | | | | 4 | | | | | |
| | 10 | | | | | | 3 | 2 | 1 | | 4 | | | | | | | | | |
| | 11 | | | | | | 3 | 2 | 1 | | | | | | | | | | | 4 |
| | 30 | | | | | | | | | | 4 | 1 | 2 | 3 | | | | | | |
| | 33 | | | | | | | | | | 3 | 2 | 1 | | | | | | | |
| | 36 | | | | | | | | | | 4 | 2 | 3 | 1 | | | | | | |
| | 31 | | | | | | | | | | | 1 | 2 | 3 | 4 | | | | | |
| | 32 | | | | | | | | | | | 1 | 2 | 3 | | | | | | 4 |
| | 34 | | | | | | | | | | | 2 | 1 | | 3 | | | | | |
| | 35 | | | | | | | | | | | 2 | 1 | | | | | | | 3 |
| | 37 | | | | | | | | | | | 2 | 3 | 1 | 4 | | | | | |
| | 38 | | | | | | | | | | | 2 | 3 | 1 | | | | | | 4 |
| | 40 | | | | | | | | | | | | | | 2 | 1 | 3 | 4 | | |
| 43 | | | | | | | | | | | | | | 1 | 3 | | 2 | | | |
| 46 | | | | | | | | | | | | | | 1 | 2 | 3 | | | | |
| 39 | | | | | | | | | 2 | | | | | | 1 | 3 | 4 | | | |

| | | | | | | | | | |
|--|----|---|--|--|--|--|--|---|---|
| | 41 | | | | | | | | |
| | 42 | 1 | | | | | | | |
| | 44 | | | | | | | | |
| | 45 | 1 | | | | | | | |
| | 47 | | | | | | | | |
| | 48 | | | | | | | | |
| | 49 | | | | | | | 2 | 3 |
| | 50 | | | | | | | 1 | 3 |
| | 51 | | | | | | | 2 | 1 |

Table 17 demonstrate the astonishing results for each six example, that are found with the help of modified CNA. It includes the composition of final cells configuration and the machines inside that cell. Beside that part families are demonstrated in the column for each cell composition.

Table 4-17.
Machine-cells and part-families from proposed model

| Ex am ple Nu mber | Cell Composition | Set of Parts |
|-------------------------------|--|--|
| 1 | {7,8,2,4}{5,6}{3,1} | {3,4,6,7,18,20}{10,15,1,5,12}{17,9,2,8,11,13,14,16,19} |
| 2 | {9,8,4,1}{7,10,11,12}{6,5,3,2} | {1,3,4,5,6,7,8,9,2,10} {15,16,12,14,17,18,13,19}{11} |
| 3 | {9,12,18,1,10}{2,3,11,14}{16,17,5}{7,15,6,4,13}{20,19,8} | {1,9,12,17,20,14}{4,2,19,11}{6,15,7} {13,5,8,16}{3,10,18} |
| 4 | {13,2,12,4,6}{9,15,1,11,5} {10,18,16,8,3}{17,7,14} | {1,10,11,12,23,24,34,9}{5,18,21,30,31,6,4,16, ,17,19,28,29}{3,7,8,14,15,32,20,27} {22,25,26,35,2,13,33} |
| 5 | {16,7,18,4}{10,9,8}{13,14} {15,22,21,6}{5,19}{2,1,17,24} {3,20,11,25}{12,23} | {1,7,16,30,17,5}{19,21,28,10,22,38} {11,32,18}{25,35,40,27,29}{8,15,23,24,31} {2,36,12} {3,9,13,14,33}{4,6,26,34,37,39,20} |
| 6 | {16,5,2}{6,12,19,7}{18,8,3,11} {19,10,14,17,20}{4,15,13} | {14-29,12,13}{1,3,6,7,2,4,5,8-11} {30,33,36,31,32,34,35,37,38} {40,43,46,39,41,42,44,45,47,48}{49,50,51} |

Chapter 5

CONCLUSION AND LIMITATIONS

In the global market, firms have the aim to achieve a higher level of integration between designed and manufacturing functions which lead the operations more efficient and productive. To achieve this objective, Group Technology is one of the astonishing achievement in lean production. In a similar way, Cellular manufacturing, an application of Group Technology (GT) to manufacturing, is implemented the GT concept by splitting manufacturing systems into cells such that the same cell is processed all alike parts. Cell formation is one of the main concerned in the design of a CMS.

This study provides acquaintance with layouts and production types practiced in industries. It confronts with the challenges in current production system, like increased production time, high level of in-process inventory, high production cost, and low production rate. Literature review on various research works unveils that CMS is rife with methods and technique but the constraints (i.e. maximum machine capacity in any cell, volume and demand of the product, sequence order of machines processed part) hamper the methods to meet in real life production systems. This motivated to propose a new model undertake all constraints. The proposed methodology in this thesis is very useful for looking at some natural inputs data and constraints met in real life production systems. This research study is the extended work of Boe and Cheng's "Close Neighbour Algorithm" [52], will pioneered a new direction to think CMS. Thus, this study proposes "A Modified Close Neighbour Algorithm for Designing Cellular Manufacturing System".

The quest for perfection on Close Neighbour Algorithm, the methodology chapter explains its pros and cons. Its deficit pioneers a new sequence based similarity coefficient model and leads to a grouping efficiency model to compare result with references. In the analysis phase, a brief demonstration of its advantages via comparing to the existing methods with six examples are noted. For validating the proposed heuristic method, a Matlab program in Dell Vostro 1015 series model using Matlab R2014a program is developed. It helps to find the solution matrix with ease of

simplicity and also given the computation time measurement which further helped to understand the complexity of the problem. Table 18 demonstrates the overall conclusion of the comparison of six examples with proposed method.

Group technology is the most promising field in order to become any organization to lean. Here a heuristic method is proposed that can solve the problem of cell formation based on similarities among the part component. It's included natural input data like the sequencing of machines, their weights, limitation of machines in cells, but still it can't include some aspects that're its limitation and that may become future scope.

- ❖ Flexible routing can be concerned which allow more flexibility to the part component to processed in the different sequencing way.
- ❖ Scheduling of machines are not considered in this thesis, so it may become further research objective.
- ❖ How the manpower affect the processing of machine, may become the future scope.

Table 5-1. Performance of Proposed model on test examples.

| Problem Number | Size (axb) | Weight | Number of Visits | Grouping Efficiency (Percentage) | Computation Time*(Second) | Best result from Literature |
|-----------------------|-------------------|---------------|-------------------------|---|----------------------------------|------------------------------------|
| 1 | 8X20 | Equal | Single | 70.39 | 0.084 | 70.39 ²¹ |
| 2 | 12X19 | Unequal | Multi | 64.73 | 0.115 | 59.38 ⁵⁸ |
| 3 | 20X20 | Equal | Single | 72.68 | 0.117 | 72.68 ⁵⁶ |
| 4 | 18X35 | Equal | Multi | 68.17 | 0.172 | 60.68 ^{29,58} |
| 5 | 25X40 | Equal | Single | 67.60 | 0.187 | 67.06 ²¹ |
| 6 | 20X51 | Unequal | Single | 65.33 | 0.170 | 63.43 ⁵⁸ |

- *: DELL-VOSTRO 1015 (Matlab R2014a)
- x^y : x is grouping efficiency and y stands for reference