

A
Dissertation Report
On
**Medical Image Fusion Based on Type-2 Fuzzy Logic in Non-Subsampled
Contourlet Transform Domain**

submitted in partial fulfilment of the requirements for the degree of

Master of Technology
In
Electronics & Communication Engineering

By

Nikita Songara
(2017PEC5460)

Under the Supervision of

Dr. K. K. Sharma

Professor

Department of Electronics & Communication Engineering

MNIT, Jaipur, India



DEPARTMENT OF ELECTRONICS & COMMUNICATION ENGINEERING
MALAVIYA NATIONAL INSTITUTE OF TECHNOLOGY, JAIPUR

June 2019



DEPARTMENT OF ELECTRONICS & COMMUNICATION ENGINEERING
MALAVIYA NATIONAL INSTITUTE OF TECHNOLOGY
JAIPUR (RAJASTHAN)-302017

CERTIFICATE

This is to certify that the thesis entitled “**Medical Image Fusion Based On Type-2 Fuzzy Logic In Non-Subsampled Contourlet Transform Domain**” which is submitted by **Nikita Songara (2017PEC5460)** in partial fulfillment of requirement for degree of Master of Technology in Electronics & communication Engineering submitted to **Malaviya National Institute of Technology Jaipur** is a record of students own work carried out under my supervise on. The matter in this report has not been submitted to any university or institution for the award of any degree.

Date:
Place:

Dr. K. K. Sharma
Professor
Dept. of ECE.
MNIT, Jaipur, India



DEPARTMENT OF ELECTRONICS & COMMUNICATION ENGINEERING
MALAVIYA NATIONAL INSTITUTE OF TECHNOLOGY
JAIPUR (RAJASTHAN)-302017

DECLARATION

I, Nikita Songara, hereby declare that this thesis is submission titled as “**Medical Image Fusion Based on Type-2 Fuzzy in Non-Subsampled Contourlet Transform Domain**”, is my own work and that, to the best of my knowledge and belief. It contains no material previously published or neither written by another person, nor material which to be substantial extent has been accepted for the award of any other degree by the university or other institute of higher learning. Wherever I used data (Theories, results) from other sources, credit has been made to those sources by citing them (to the best of my knowledge). Due care has been taken in writing this thesis, errors and omissions are regretted.

NIKITA SONGARA

ID: 2017PEC5460

ACKNOWLEDGMENT

I would like to thank all peoples who have helped me in this project, directly or indirectly. I am especially grateful to my supervisor **Prof. K. K. Sharma** (Dept. of ECE, MNIT Jaipur) for his invaluable guidance during my project work, encouragement to explore parallel paths and freedom to pursue my ideas. My association with him has been a great learning experience. He made it possible for me to discuss with a number of people and work in different areas.

I express my sincere gratitude to Professor **D. Boolchandani** (Head of Department) for his support and guidance in this research work. Many thanks to committee members Dr. Satya Sai Nanda (Assistant professor) Dr. Ghanshyam Singh (Associate Professor), for their valuable comments and guidance in research exploration, without this guidance, it was not possible to achieve these good results in this research work.

I would like to thank my husband **Mr. Kapil Parihar** (Assistant professor in M.B.M Engineering College Jodhpur) for their valuable suggestions and discussion, which I had with them about this research work. He helps me in designing work of my project. And I also thank for his affection, encouragement, understanding, and patience.

I would like to thank my parents for unconditional love and support throughout my education career.

I am also very thankful to my friend **Akanksha Tiwari** and my siblings **Vanita Songara, Arence Chouhan, Yogesh Songara, Kriti Solanki, Milan Chouhan, and Varnika Chouhan** have been a continuous source of inspiration and encouragement.

I would like to thank the Ministry of HRD, Government of India for its support to me to pursue my Masters in Wireless and Optical Communication Engineering from Malaviya National Institute of Technology, Jaipur. This support provided me library, laboratory, hostel, and other related infrastructure.

I would like to thank to “God” for giving me the strength and encouragement, especially during all the challenging moments in completing this thesis. I am truly grateful for your exceptional love and grace during this entire journey”.

Finally, my thanks go to all the people who have supported me to complete the research work directly or indirectly.

NIKITA SONGARA

TABLE OF CONTENTS

CERTIFICATE	i
DECLARATION	ii
ACKNOWLEDGMENT	iii
TABLE OF CONTENTS	iv
ABSTRACT	vii
LIST OF FIGURES	viii
LIST OF TABLE	ix
LIST OF ABBREVIATIONS	x
CHAPTER 1.....	1
INTRODUCTION	1
1.1. BACKGROUND:	1
1.1.1. Categories of fusion Methods:.....	2
1.2. INTRODUCTION TO RESEARCH DOMAIN.....	3
1.2.1. Methodology Part	3
1.2.2. Simulation Part	4
1.3. MOTIVATION	4
1.4. OBJECTIVE	4
1.5. FUTURE SCOPE	5
CHAPTER 2.....	6
LITERATURE SURVEY	6
2.1. PRINCIPAL COMPONENT ANALYSIS (PCA) BASED IMAGE FUSION:.....	6
2.2. WAVELET TRANSFORM BASED IMAGE FUSION:	6
2.3. DUAL-TREE COMPLEX WAVELET TRANSFORM BASED IMAGE FUSION:.....	7
2.4. CURVELET TRANSFORM BASED IMAGE FUSION:	8

2.5.	CONTOURLET TRANSFORM BASED IMAGE FUSION:.....	9
2.6.	NON-SUBSAMPLED CONTOURLET TRANSFORM.....	9
2.6.1.	Non-subsampled Contourlet and Filter Banks:	10
2.6.2.	Combining the Non-subsampled Pyramid and Non-subsampled Directional Filter Bank in the NSCT:	12
2.7.	FUZZY LOGIC AND FUZZY SET:.....	13
2.7.1.	Fuzzy Logic	13
2.7.2.	Type-2 fuzzy logic:.....	14
2.7.3.	Gaussian Type-II Fuzzy logic:	15
2.7.4.	Interval Type-II Fuzzy Sets:	16
2.8.	Extension Principle:	17
CHAPTER 3.....	18	
MODIFIED METHOD	18	
3.1.	MATHEMATICAL ANALYSIS OF MODIFIED METHOD	18
3.2.	FLOW CHART OF MODIFIED METHOD	20
3.3.	STEPS FOR THE MODIFIED.....	20
CHAPTER 4.....	22	
RESULT AND COMPARISON.....	22	
4.1.	RESULT EVALUATION CRITERIA	22
4.1.1.	Mutual Information (MI)	22
4.1.2.	Edge-Based Similarity Measure (QAB/F).....	23
4.1.3.	Standard Deviation (STD).....	23
4.2.	SIMULATION RESULTS	23
4.2.1.	Images Database	24
CHAPTER 5.....	26	
CONCLUSION AND FUTURE WORK.....	26	
5.1.	CONCLUSION.....	26

5.2. FUTURE WORK.....	26
REFERENCES	28

ABSTRACT

Image fusion in the medical field plays a significant job in different medical imaging sensor applications. Medical image fusion methodology present in this thesis. In this image, fusion methodology utilizes the non-subsampled contourlet transform (NSCT), type-2 fuzzy logic, and The Yager entropy techniques. To begin with, the NSCT was implemented on input images or pictures to gotten high-frequency and low-frequency sub-bands images. Then, the type-2 fuzzy logic-based fused algorithm is created for image fusion of the high-frequency sub-bands. Be that as it may, for the low-frequency sub-band image, it was fused by a local energy (LE) algorithm, which is based on the input image's local features. In the end, the fused image was created by the inverse NSCT.

Keywords:-Medical Image, Non-Subsampled Contourlet Transform, Yager Entropy, Type-2 Fuzzy Logic.

LIST OF FIGURES

FIGURE 1 IMAGE FUSION CLASSIFICATION [3]	3
FIGURE 2 IMAGE FUSION THROUGH WAVELET TRANSFORMS [21]	7
FIGURE 3 DT-CWT BASED FUSION OF IMAGE	8
FIGURE 4 CURVELET TRANSFORM	8
FIGURE 5 BLOCK DIAGRAM OF CONTOURLET TRANSFORM [22]	9
FIGURE 6 A NON-SUBSAMPLED CONTOURLET DECOMPOSED SCHEMATIC DIAGRAM [19]	10
FIGURE 7 NON-SUBSAMPLED PYRAMID STRUCTURE. HERE $Z=JW$ [19].....	11
FIGURE 8 TWO-CHANNEL NSFBS USED IN THE NSCT. HERE $Z=JW$ [22]	13
FIGURE 9 FUZZY LOGIC CONTROLLER [23]	14
FIGURE 10 ORDINARY VS. PERTURBED FUZZY SET. [23]	15
FIGURE 11 TYPE-II GAUSSIAN FUZZY SET PORTRAYED FROM THE ABOVE VIEW.	16
FIGURE 12 TYPE-2 FUZZY LOGIC CONTROLLER [23].....	16
FIGURE 13 TWO TYPES OF TYPE-II GAUSSIAN PRIMARY MEMBERSHIP FUNCTIONS [11].....	17
FIGURE 14 THE BLOCK DIAGRAM OF THE MODIFIED IMAGE FUSION.	20
FIGURE 15 SOURCE MULTIMODAL MEDICAL IMAGES: (A), (B) IMAGE GROUP1 (CT AND MRI)	24
FIGURE 16 PREVIOUS SCHEME IN [19]	24
FIGURE 17 TYPE 2 FUZZY LOGIC WITH THE YAGER ENTROPY	25

LIST OF TABLE

Table 1 Tabular comparison of Evaluation indices for fused medical images.....25

LIST OF ABBREVIATIONS

NSCT	NON-SUBSAMPLED CONTOURLET TRANSFORM
DWT	DISCRETE WAVELET TRANSFORM
DT-CWT	DUAL-TREE COMPLEX WAVELET TRANSFORM
CVT	CURVELET TRANSFORM
NSP	NON-SUBSAMPLED PYRAMID
NDFB	NON-SUBSAMPLED DIRECTIONAL FILTER
MRI	MAGNETIC RESONANCE IMAGING
CT	COMPUTED TOMOGRAPHY
MI	MUTUAL INFORMATION
STD	STANDARD DEVIATION

CHAPTER 1

INTRODUCTION

1.1. BACKGROUND:

Image fusion is a combining process of two or more than two source images from different modalities into a single image with greater information. Image fusion is of great importance in many applications, such as remote sensing, computer vision, medical imaging, etc. Aim of Image fusion methods to obtain images with high spectral and spatial resolution. In the pixel level fusion, some generic requirements can be imposed on the fusion results [1] [2]

- The fused image should save all important information, which contained all the information of source image.
- The image fusion process should not introduce rarities or irregularities, which can divert or misdirect the human observer.
- In the image fusion, unimportant features of image and noise added in the image should be suppressed to a most extreme degree.

We divide the image fusion as indicated by the data entering the combination and as per propose of fusion of image. There are four types of fusion of images, which are written below. [20]

- 1 The multi-view image fusion: In this type of image fusion use the same image at the same time, but viewpoints are different.
- 2 The multi-modal image fusion: In this type of image fusion use various pictures originating from various sensors like visible and infrared (IR) images or panchromatic and multi-spectral satellite images.
- 3 The multi-temporal image fusion: In this type of image fusion picture taken on various time. It is used to recognizing changes between various time or to integrate unique pictures of objects. These types of the fused image were not photographed in a desired time. The multi-focus fusion of image: In this type of

fusion of images take 3-Dimensional pictures persistently with various central or focal length.

1.1.1. Categories of fusion Methods:

A multispectral image or various sensor images can be fused using different methods. These are three types of fusion method, which are written below:-

- Pixel Level,
- Data Level or Feature Level Fusion
- Decision Level Fusion.

A. Pixel level fusion method:-

In this type of image fusion, the pixel level use for fusion of input image. It uses arithmetic operations, equivalent pixel intensity from different input images. It used in frequency domain for image fusion. Because in this use frequency domain, so input images are first transformed into the frequency domain using different types of pyramid based methods like Wavelet transforms or Laplacian. After transformation in frequency domain, algebraic operations are performed on the input images. Further this image is fusing to one image. Then, this fused image is inverse transformed. The algebraic rule which used fir image fusion that based on intensity, on pixel contrast, or on weight of a specific spectrum.

B. Feature level fusion method:-

In this type of image fusion, first features of input image will be extracted, and then apply image fusion based on these features of the image. Feature-based template methods algorithms used for this type of fusion. For example edge enhancement, Artificial Neural Networks, and knowledge based approaches.

C. Decision Level Fusion method:-

In this type of image fusion first the features of input image will be extracted. Then a decision will be make on every point of input, and take the decisions for image fusion.

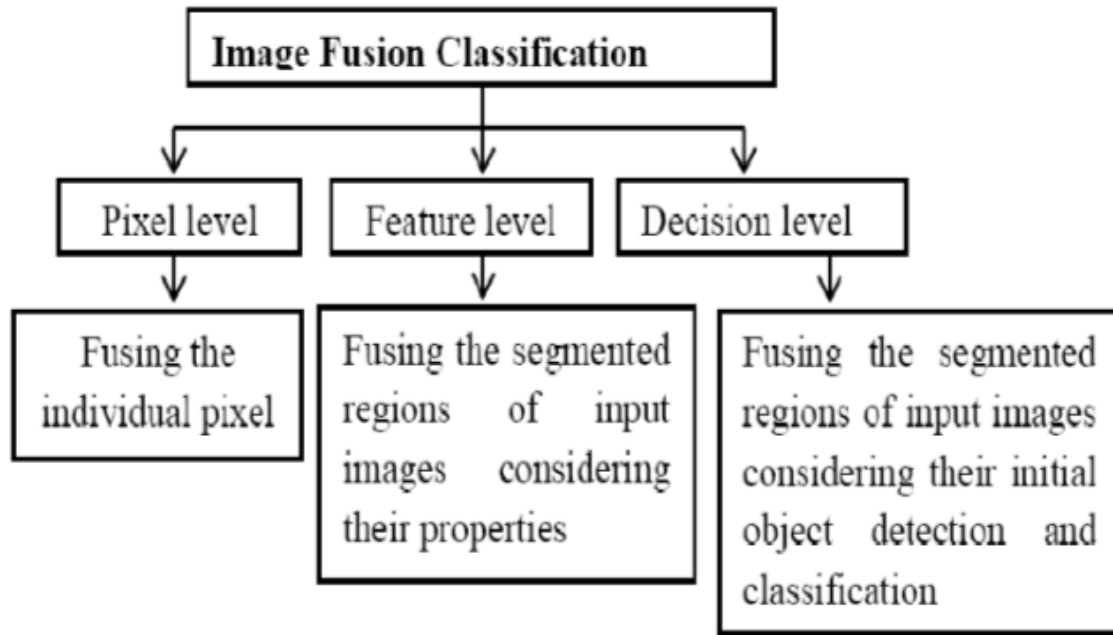

Figure 1 Image fusion classification [3]

1.2. INTRODUCTION TO RESEARCH DOMAIN

In the ongoing years, medical image division is the primary research subject of image processing applications. This performs different kind of volumetric and shape examination of different structures. An application of medical image division with respect to segmenting cerebrum is utilized in research to describe neurological problem such as; Alzheimer's, multiple sclerosis, and schizophrenia. Exact brain division gives volume estimations that can identify the beginning of degenerative diseases. Medicinal imaging is isolated into auxiliary and utilitarian frameworks.

In the view of literature of different techniques of image fusion, I proposed another strategy which is reasonable in theory which in advance is verified by simulations. The entire research could be divided into two parts first, theory part and another one is simulation part.

1.2.1. Methodology Part

- Firstly, the task is to learn, more on the background of image fusion, current situation practical methods, Principle of Non-Subsampled Contourlet transform, type-2 fuzzy logic, different types of entropy also fusion rules, etc.

- The second phase is comparison analysis to select better image fusion solution with good effect.
- Via information collection and analysis, modified fusion method, which is based on type-2 fuzzy logic with the Yager entropy in the NSCT domain, which is practically supported by theory.

1.2.2. Simulation Part

- Design experiments to simulate fusion procedure based on NSCT with type-2 fuzzy logic. With registering Standard brain MRI and CT image as source images, the modified fusion method is used to fuse two original images into one image.
- Collect experiment data and use subjective evaluation and objective evaluation to assess the fusion effect.
- To escape deviation and ensure the stability of the methods, do the same experiments multiple times, and compare results.

1.3. MOTIVATION

With the advancement of information innovation and medical technology, numerous sorts of image fusion applications are in effect broadly utilized nowadays. The most effective method to manage the therapeutic pictures from various methodology turns into a key research field for which image fusion was presented. Picture combination has been utilized in numerous application fields. The medical field applications. Multi-modular picture combination is utilized to accomplish high spatial and otherworldly goals by mixing pictures from two different-different sensors, initial one high spatial goals, and the other one high ghastrly goals. By utilizing image combination technology, we can develop a new combined image. It will contain more information and complete with respect to different source images.

1.4. OBJECTIVE

The primary goal is the design an algorithm which gives the efficient, accurate and precise fused image to diagnose the disease like a tumor in any part of the brain and any dimension

without losing data at this point give better resolution for uneven and bent states of human parts.

1.5. FUTURE SCOPE

The algorithm which I developed used for registers the interpatient medical multi methodology fused images for finding of disease taken at a different time interval. In the future, for comparison and find of similarities of disease between two patients, the same algorithm can be developed for the diagnosis of intra-patient medical images.

CHAPTER 2

LITERATURE SURVEY

Since last few years, a broad number of approaches to have managed to combine visual picture data. These procedures change in their multifaceted nature, power, and modernity. Remote detecting is maybe one of the main picture combination applications with an enormous number of devoted distributions. The primary guideline of a portion of the famous picture combination algorithms has been discussed below.

2.1. PRINCIPAL COMPONENT ANALYSIS (PCA) BASED IMAGE FUSION:

The PCA picture combination technique [4] basically utilizes the pixel estimations of all input pictures at each pixel region, adds a weight factor to each pixel area, and takes a normal of the weighted pixel regards to convey the result for the merged picture at a similar pixel area. The PCA system controls the optimal weighted components. The PCA picture combination strategy decreases the repetition of the picture data.

2.2. WAVELET TRANSFORM BASED IMAGE FUSION:

Wavelet transformed based picture combination method technique decomposition of pictures into various components. These part dependent on their nearby frequency content. The Discrete wavelet transform (DWT) apply on multi-model images like MS and PAN images. They extract the low-frequency information data from the MS picture and the high-frequency information data from the PAN picture. The Fused Wavelet Coefficient Map is created by fusing these images. Then the final PAN-sharpened image (fusion of MS and PAN images) is created by performing inverse wavelet transform. In figure 2 show DWT of two source images.

In any case, wavelets are constrained in catching directional data in two-measurement. Disregarding wavelets are great at detaching the breaks at edge focuses, and they can't successfully speak to the 'line' and the 'bend' discontinuities appropriately. Besides, individual wavelets can catch just confined directional information, and consequently can't speak to the bearings of the edge unequivocally. So these isotropic wavelets are inadequate

of shift-invariance and multi-directionality. What's more, they are neglect to give a perfect articulation of exceedingly an-isotropic edges and shapes in pictures.

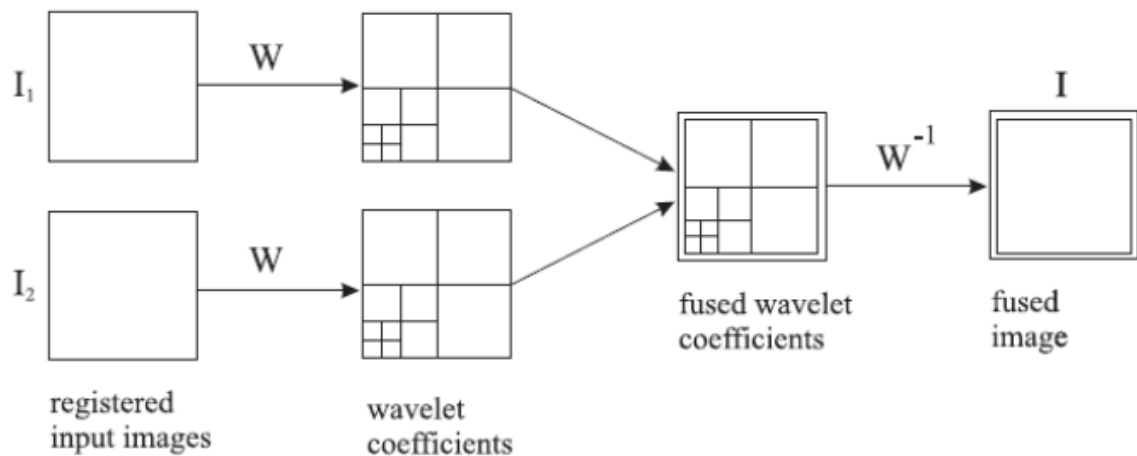

Figure 2 Image fusion through wavelet transforms [21]

2.3. DUAL-TREE COMPLEX WAVELET TRANSFORM BASED IMAGE FUSION:

Nick Kingsbury first presented the Dual-Tree Complex Wavelet Transform (DT-CWT) in the year 1998. The DT-CWT has been a standout amongst the most famous transform techniques. It has some unique features, for example, the best shift-invariance, the best directional selectivity in 2-Dimensional and 3-Dimensional, immaculate remaking utilizing short help channels, constrained excess and low calculation. The DT-CWT [5] use two real DWTs, the 1st yields the genuine piece of the transform, and another yield the fanciful part.

At each disintegration dimension of DT-CWT, six directional high recurrence wavelet component is created with two low recurrence components.

The DT-CWT components of every band of frequency are mixed, utilizing some reasonable combination rules. Inverse DT-CWT use for finding the new fused image. The complete image fusion flow chart is shown below in Fig.3.

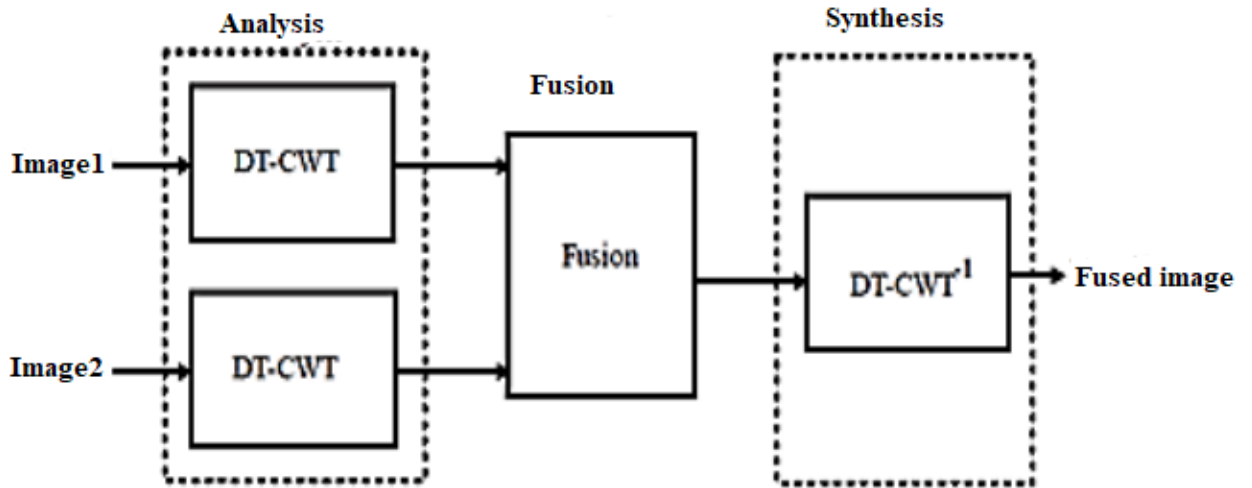

Figure 3 DT-CWT based Fusion of image

2.4. CURVELET TRANSFORM BASED IMAGE FUSION:

The SWT, DWT, and DT-CWT can't capture bends and edges of images. They consist of the numerical format of data when it is utilized to represent pictures. Candes and Donoho give the Curvelet transform (CVT) with the idea of representing a curve as a superposition of bases of different lengths of width complying with the scaling width length. [6] The CVT called "true" 2-Dimensional transform. For a discrete version of the transform executed is a "wrapping" transform. 2nd era of the CVT is shown in Fig: 4. First, apply the 2-Dimensional FFT on the input picture to find the Fourier samples. Second, apply a discrete limiting window, the Fourier transform close to the sheared wedges complying the illustrative scaling. At that point, the wrapping is connected to re-file the information. Then last apply, the inverse 2D FFT is utilized to get the discrete CVT components.

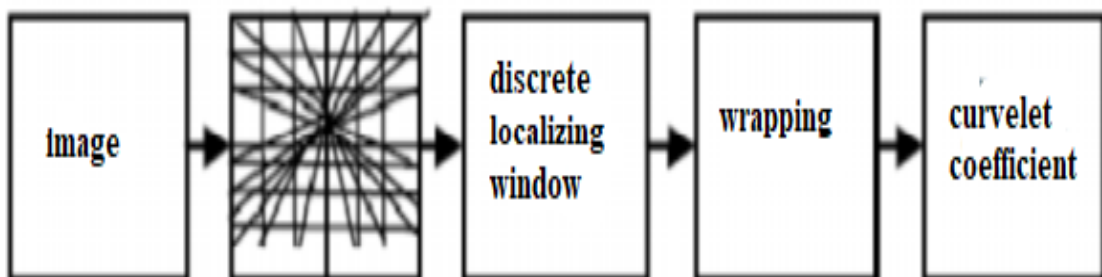

Figure 4 Curvelet transform

2.5. CONTOURLET TRANSFORM BASED IMAGE FUSION:

The CT is 1st created in the continuous time domain, and afterward, it is converted into discrete information for sampled information; it begins with the discrete domain development. It is called a true 2-Dimensional image capture intrinsic numerical format of a picture. Two channel banks are utilized to execute the CT.

First used the Laplacian pyramid to catch the point of discontinuities, and second used a directional filter bank to the connection point of discontinuation. Utilizing the down-sampling operation is no shift-invariant equity into the CT, which is similar to the DWT.

Do, and Vetterli starts to get a sparser portrayal 2-Dimensional piece-wise smooth capacities in R^2 . A successful technique is used a two filter bank plot, 1st apply a multi-scale decomposition to catch the point of discontinuation plus besides playing out a local directional decomposition to combine the adjacent edge focuses in autonomous contour coefficients.

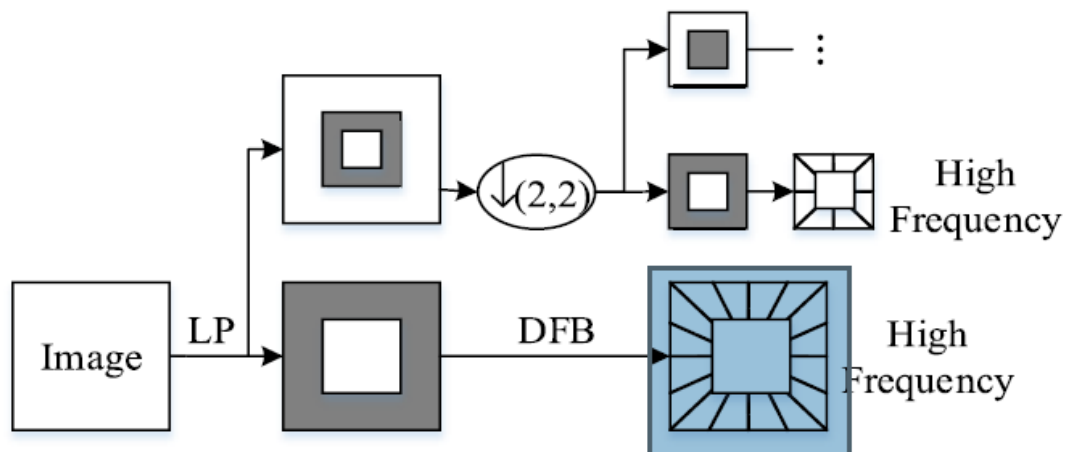

Figure 5 Block Diagram of Contourlet Transform [22]

2.6. NON-SUBSAMPLED CONTOURLET TRANSFORM

For the most recent decade, wavelets had had growingly affected image processing because of their great non-linear estimation execution for piece-wise smooth functions in one dimension. CT [7]. It proposed by Do and Vetterli. It is an amazing picture fusion technique. Distinguish with the conventional WTs the CT isn't just with multi-scale and limitation yet also with multi-bearing and, isotropy. Thus the CT can show bind and different aberration along with twists considerably more productively. Be that is may, the CT does not have the

shift-invariant, which is alluring in many pictures applications for examples picture de-noising, picture enhancement and picture combination based on NSCT, [7] given by Cunha, acquires the optimized property of the CT, and it is the shift-invariant. At the point, the NSCT in applied to source picture for image combination at that point, most extreme data for combination can be gotten, a methodology for PAN and MS picture combination utilizing the NSCT.

NSCT is shift-invariant, but the CT is not shift-invariant. So when CT is examined with down-sampling and similar to the up-sampling shifting of source image samples causes Pseudo-Gibbs phenomena around aberration. Cunha gives one phase before the CT is NSCT. The NSCT is a shift-invariance type of CT. Shift- channel banks fulfilling “Bozout identical equation” are realized for differentiation of NSCT from the CT. The NSCT is the shift invariance type of CT. It gives either a multi-resolution examination or numerical and directional portrayal. Two level NSCT deterioration flow chart is shown in Figure 6.

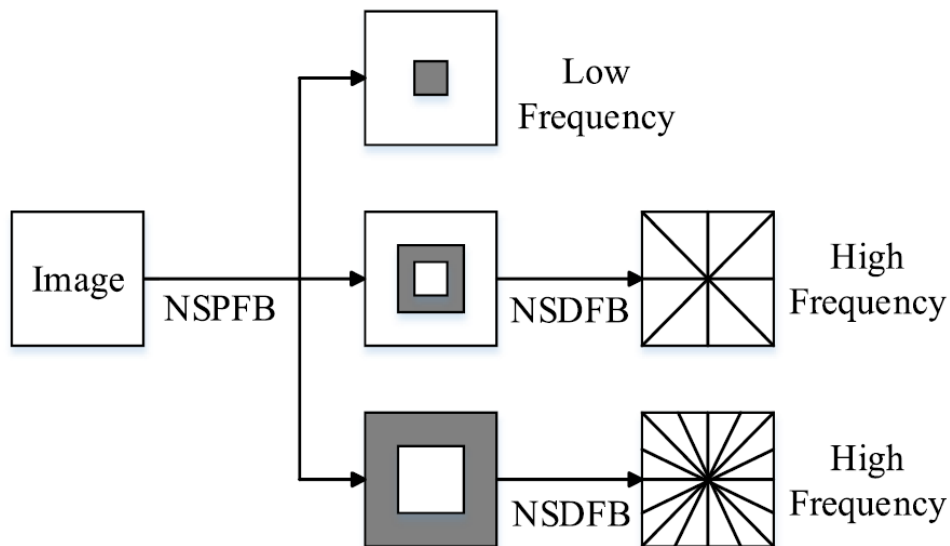

Figure 6 A non-subsampled contourlet decomposed schematic diagram [19]

2.6.1. Non-subsampled Contourlet and Filter Banks:

The blocks of the NSCT comprises filter banks which parts the two Dimensional frequency plane in the sub-bands. NSCT is additionally separated into two types of filter bank:

- Non-subsampled pyramid (NSP) structure:-which guarantees the multi-scale property.

- Non-subsampled Direct a national Filter Bank (NDFB):-It's structures that give directionality.

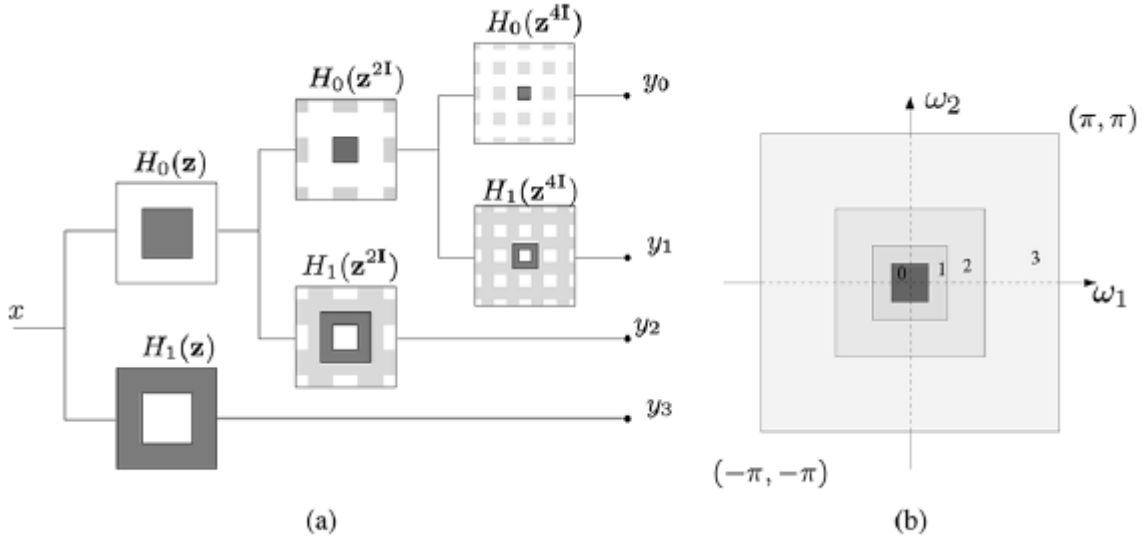

Figure 7 Non-subsampled pyramid structure. Here $Z=jW$ [19]

(a) Three-stage pyramid decomposition. (b) Sub-bands on the 2-D frequency plane.

(A) Non-subsampled Pyramid Filter Bank:

The multi scalar type of the NSCT is gotten from a shift invariance filtering blocks accomplishes a sub-band decay like that LP. It is accomplished by utilizing two channel non-subsampled two Dimensional channel banks. Fig 7 delineates proposed NSP deterioration with $I = 3$ levels. These type of extension is the same as the one-dimensional Non-subsampled Wavelet Transform (NSWT). Which is processed with an algorithm. Name of the algorithm is the trous algorithm. It has $I + 1$ repetition, and here 'I' is equal to the number of decomposing levels. The perfect band-pass backing of the low-pass channel at the level of i^{th} . It is the district $[(-\pi)/2^i, \pi/2^i]^2$. As needs are, an ideal help of comparable high-pass channel is a supplement of the low-pass channel, for example, the area $[(-\pi)/2^{(i-1)}, \pi/2^{(i-1)}]^2 / [(-\pi)/2^i, \pi/2^i]^2$. The channels for consequent levels are gotten through up-sampling the channel of 1st level. It gives multi-scalar type without the necessity for additional channel plan. The structure which is proposed is therefore not quite t same as NSWT. Specifically, the first band-pass picture is created at every level, there for the subsequent redundancy $I + 1$. Conversely, NSWT creates three directional pictures at every

level there for subsequent redundancy is $3I + 1$. The perfect condition for reconstruction is written below: [22]

$$H_0(jW) * G_0(jW) + H_1(jW) * G_1(jW) = 1 \quad (1)$$

The NSF is worked from low-pass channel $H_0(jW)$. One at that point $H_1(jW) = 1 - H_0(jW)$. The comparing unique channels $G_1(jW) = G_0(jW) = 1$. Comparable deterioration should be by expelling the up-sampler & down-sampler into LP & after up-sampling the channels like manner. The ideal remaking frameworks can be viewed as a specific instance of an increasingly broad structure. The benefit of development in general, and as indicated by the result, for the best channels can be gotten. Specifically, structure $G_0(jW)$ and $G_1(jW)$ are low-pass and high-pass. As needs are, they channel a certain bit of the clamor range in the handled pyramid mixes.

(B) Non-subsampled Directional Filter Bank

The NSF is a shift invariance type of the fundamentally sampled DFB in CT. Structure square graph of a NSF is two channels NSF. Be that as it may, the recurrence reaction for a NSF is changed. To get better directional decomposition, iterate NSF. For the following dimension, Up-sample all channels by the quincunx matrix. Which is written below:[22]

$$Q = \begin{bmatrix} 1 & 1 \\ 1 & -1 \end{bmatrix} \quad (2)$$

2.6.2. Combining the Non-subsampled Pyramid and Non-subsampled Directional Filter Bank in the NSCT:

The NSCT is built through consolidating NSF & NSP. For developing NSCT, protection must be taken to apply the DFB to the coarser size of the pyramid. Due to the tree-structure nature of the NSF, the directional reaction at the lower and upper frequencies experiences associating, which makes an issue in the upper phases of the pyramid. Consequently, for coarser size, the high-pass diverts in actuality is separated with the terrible bit of the directional channel band-pass. Its outcomes is extreme aliasing what's more, in some watched cases, a significant loss of directions goal. To cure this, utilizing sensible up-sampling the NSF channels. Mean of j^{th} directional channel by $U_j(jW)$. At that point of upper levels, substitute $U_j(jW)_{2n}$ for $U_j(jW)$, where n is picked guarantee, a great piece of the reaction covers with pyramid band-pass. This change preserves perfect reconstruction.

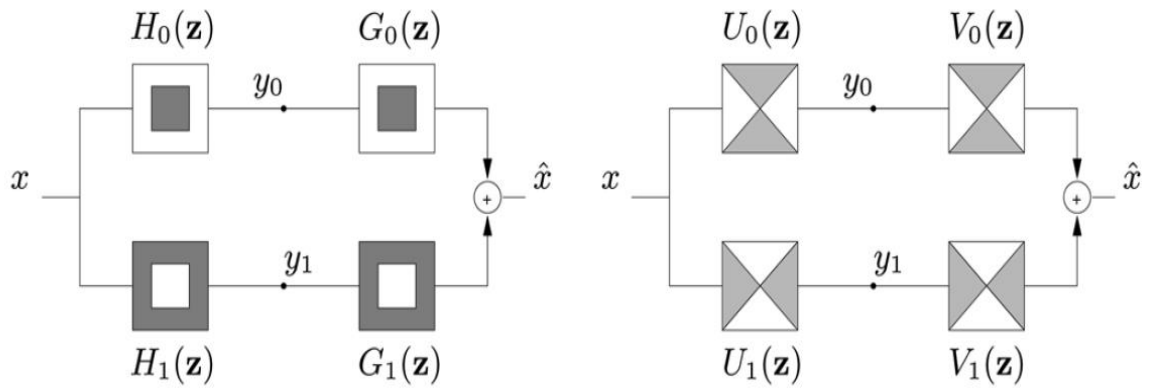

Figure 8 Two-channel NSFBS used in the NSCT. Here $Z=j\omega$ [22]

(a) Pyramid NSFB.

(b) NSDFB

2.7. FUZZY LOGIC AND FUZZY SET:

2.7.1. Fuzzy Logic

It is hypothesis has been growing as of late to impersonate the incredible capacity of human thinking to structure frameworks that can manage complex procedures. Definition of fuzzy sets is set which containing components with variable membership functions [9]. It is not the same as classical (crisp) sets where components have full membership in fuzzy set (i.e., their membership is equal to one). components of a fuzzy set are maps a vast expanse of participation membership values utilizing a capacity theoretic form. Function mapped components of the fuzzy set a genuine worth having a place with the interim $[0, 1]$.

Fuzzy sets hypothesis helps demonstrate perplexing and uncertain frameworks. It has additionally been utilized in all respects adequately in the region of control as a basic leadership framework. [5] A fuzzy logic rationale controller comprises of four principal segments: first is the fuzzifier interface, second is knowledge base, third is inference engine, and the last one is the defuzzifier interface.

The fuzzifier interface plays out a scale mapping that moves estimations of the information factors into comparing universes of talk.

The knowledge base comprises of a database that contains a procedure portrayal, and a phonetic (fluffy) control standard base that mirrors the control objectives.

The inference engine is the kernel of the FLC. It reproduces the human basic leadership rationale and produces control activities dependent on standards of deduction.

In contrast to the fuzzifier interface, the defuzzifier elements produce a crisp valued control activity. A few defuzzifier techniques are famous. The most well-known techniques are the centroid of the area method, the center of sums method, and the mean of maxima method. Further details on this could be found in [10], [11],

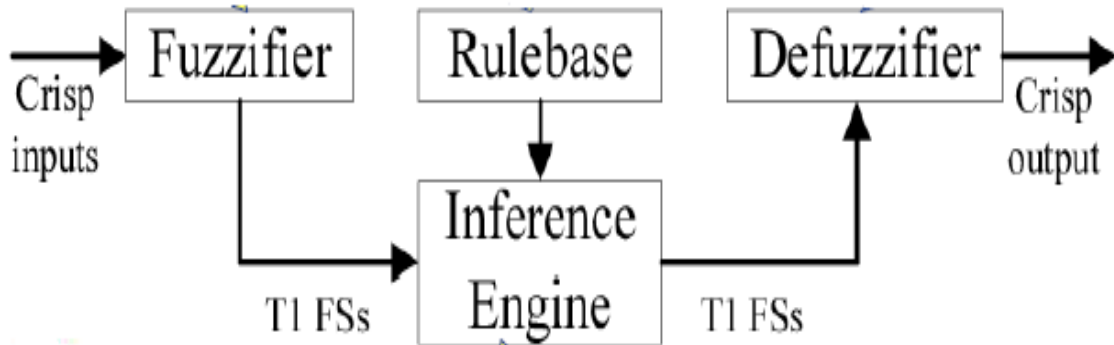
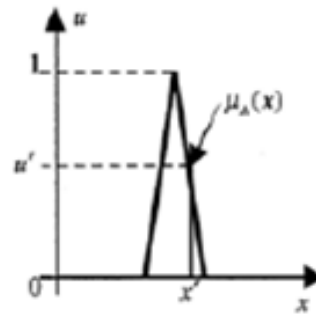

Figure 9 Fuzzy logic controller [23]

2.7.2. Type-2 fuzzy logic:

In this subsection, we provide definitions for Type-II fuzzy sets (T2FSs) and the related but important concepts. It helps us to communicate effectively by laying a well-defined foundation for the language we use extensively through the rest of this thesis. Think about an ordinary fuzzy set shown in Figure 10(a). What if we blur the portrayed membership function to moving (not necessary event) the points on the triangle up and down? Figure 10(b) shows the modified image. In this manner for a specific value in the domain, say x_0 , there will not be any unique membership grade attributed to it, rather the membership values now take on a continuous set of real values. We can also ascribe a real value in $[0,1]$ to each element of the set below to make up the third dimension. This second membership function is called secondary membership function in literature.



(A) An ordinary fuzzy sets

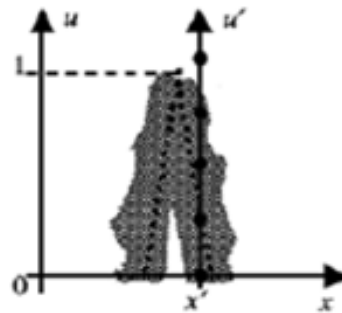

(B) Having the membership function

Figure 10 Ordinary vs. perturbed fuzzy set. [23]

Doing so for all points in the domain, we come up with three-dimensional membership function which we call it a Type-II fuzzy set (T2FS). Among general Type-II fuzzy sets, two main groups are well-known and have been employed successfully, to date, namely the Gaussian Type-II fuzzy sets & interval Type-II fuzzy sets. The former includes Gaussian secondary membership functions while the latter includes interval-valued Type-I secondary membership functions. To communicate easier through the Type-II fuzzy literature, we define the following important concepts, as well [12]:

2.7.3. Gaussian Type-II Fuzzy logic:

The secondary membership functions corresponding to the domain of a Type-II fuzzy set are Type-I Gaussian membership functions, call such a set a Gaussian Type-II set. Figure 11 depicts a 3-dimensional Gaussian Type-II fuzzy set in a 2D picture where the third dimension has been transferred to the image intensity. In the figure, the darker points

represent higher secondary membership grades, and the solid line shows those points with unity secondary membership grade.

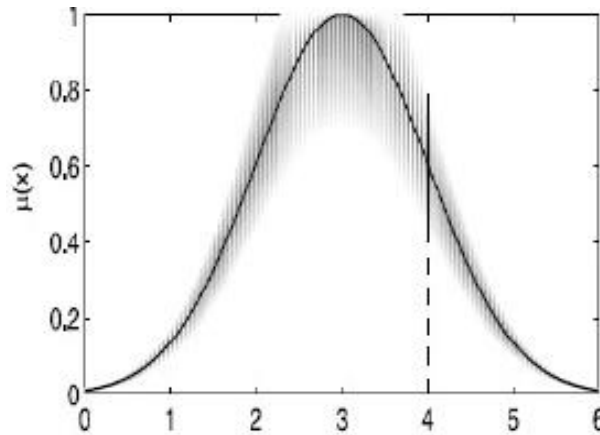

Figure 11 Type-II Gaussian fuzzy set portrayed from the above view.

2.7.4. Interval Type-II Fuzzy Sets:

An interval Type-II fuzzy set (IT2FS) is the main kind of general T2FSs in which the secondary membership functions equal to 1. The footprint of uncertainty completely defines an IT2FS. These sets are the most widely used T2FSs due to several reasons (esp. the implementation issues, demonstrated in subsequent sections.) More specifically, when all the secondary membership functions corresponding to the domain of a Type-II fuzzy set are interval Type-I membership functions, set are known as an interval Type-II set (IT2FS). [11]

An important class of interval Type-II fuzzy sets (henceforth called IT2FSs) is Gaussian primary Type-II sets. Two different types of Gaussian primary T2FSs are Gaussian IT2FSs with uncertain mean and Gaussian IT2FSs with uncertain standard deviation.

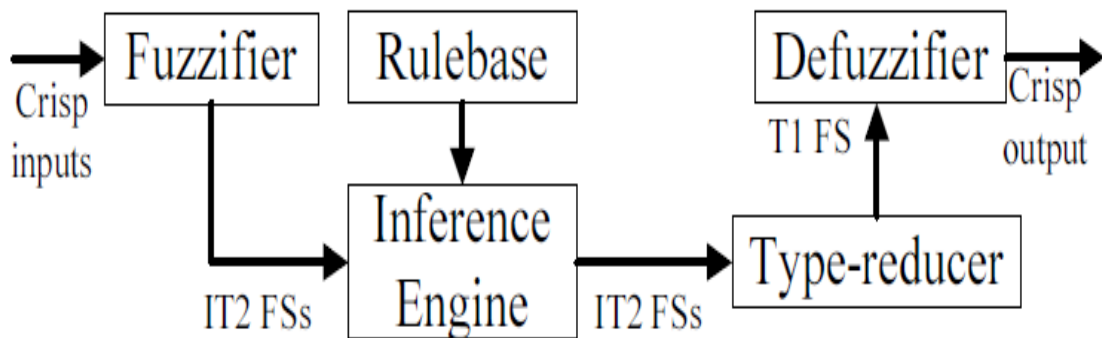

Figure 12 type-2 fuzzy logic controller [23]

2.8. Extension Principle:

This principle extends the classical operations defined in crisp mathematics to the realm of fuzzy logic. This is the basis of all T2FL analysis either explicitly or implicitly. The principle states that if an operation, is defined on a set of numbers, then its counterpart in the fuzzy domain is obtained by, [23]

$$F \otimes G = \int_u \int_w (f(u) * g(w)) / (u \otimes w) \quad (3)$$

Where the \int Sign and $*$ the denote the union and t-norm, respectively. In other words, if a relation $f(x)$, is defined on crisp variable $x \in X$ then we extend it to operate on fuzzy set, A , as follows:[23]

$$\mu_B(y) = \max_{x=f^{-1}(y)} \mu_A(x) \quad (4)$$

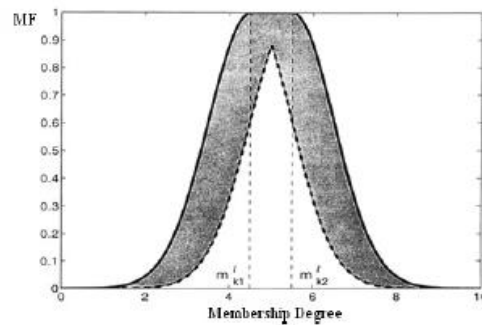

(a) Gaussian primary IT2FS with uncertain mean

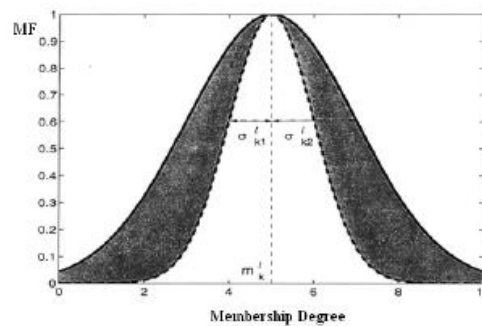

(b) Gaussian primary IT2FS with uncertain sigma

Figure 13 Two types of Type-II Gaussian primary membership functions [11]

CHAPTER 3

MODIFIED METHOD

In this chapter, details of the modified method for image fusion using type 2 fuzzy logic with the Yager entropy is described. This method used in the NSCT domain. In this chapter, the mathematical analysis, and a description of the modified method by a flow chart with steps are explained.

3.1. MATHEMATICAL ANALYSIS OF MODIFIED METHOD

- **Decomposition through Nonsubsampled Contourlet Transform:-**

Consider two source images A and B, and then applied the k level NSCT decomposition method, Then images are divided into a series of high-frequency sub-bands images at each level and direction, and one low-frequency sub-band image gotten; i.e., $A:\{H_{k,l}^A, L^A\}$, $B:\{H_{k,l}^B, L^B\}$. where k is level and l is the direction of the high-frequency subsampled image.

- **Fusion Rule for High-Frequency Sub-band Images:-**

A type-2 fuzzy logic represents every high-frequency sub-band images. The shape of the skeleton membership function $\mu(x)$ is written below: [19]

$$\mu_{k,l}^I(i, j) = \frac{1}{1 + \left| \frac{H_{k,l}^I(i, j) - c}{a} \right|^2} \quad (5)$$

Where $I = (A, B)$ and (i, j) is the spatial location of the high-frequency components in the sub-band, and $c = \text{average}(H_{k,l}^I)$ and $a = \min(H_{k,l}^I)$.

Now evaluate the lower and upper membership functions $\mu_L(x, y)$ & $\mu_U(x, y)$ are calculated below: [19]

$$\begin{cases} \mu_L^{I,k,l}(x, y) = [\mu_{k,l}^I(i, j)]^\alpha \\ \mu_U^{I,k,l}(x, y) = [\mu_{k,l}^I(i, j)]^{1/\alpha} \end{cases} \quad (6)$$

Where α is fuzzy linguistic hedge with $\alpha \geq 1$ For the best results can be obtained when $\alpha \in [1, 2]$.

Then find out the fuzzy entropy of an interval type-2 fuzzy set by the Yager entropy. [13][14]

$$E(x) = \frac{1}{2} \sum_{x \in X} (1 - |\mu_L(x)(1 - \mu_U(x))|) \quad (7)$$

Expanding it to a 2D picture plot, the introduction of local type-2 fuzzy entropy is calculated below:

$$E_{k,l}^I = \frac{1}{2} \sum_{(x,y) \in X} (1 - |\mu_L^{I,k,l}(x,y) - (1 - \mu_U^{I,k,l}(x,y))|) \quad (8)$$

where $X = \{(x, y) | x = 0, 1, \dots, M-1, y = 0, 1, \dots, N-1\}$ denotes a window of size $M \times N$.

Therefore, the fused high coefficient $H_{k,l}^F(i, j)$ follows the fusion rule

$$H_{k,l}^F(i, j) = \begin{cases} H_{k,l}^A(x, y) & E_{k,l}^A \geq E_{k,l}^B \\ H_{k,l}^B(x, y) & \text{otherwise} \end{cases} \quad (9)$$

- **Fusion Rule for Low-Frequency Sub-band Images**

The Local Energy to make fusion rules to utilize the corresponding image local features. The LE is written below:[19]

$$LE^I(L^I(i, j)) = \frac{1}{M \times N} \sum_{m=1}^M \sum_{n=1}^N (L^I(i + m, j + n))^2 \quad (10)$$

Where $I = (A, B)$, (i, j) is the spatial location of the low-frequency components in the sub-band, and $(M \times N)$ is the window size. The fusion rule is written below: [19]

$$L^F(i, j) = \begin{cases} L^A(i, j) & LE^A(i, j) > LE^B(i, j) \\ L^B(i, j) & LE^A(i, j) < LE^B(i, j) \\ \frac{1}{2}(L^A(i, j) + L^B(i, j)) & \text{otherwise} \end{cases} \quad (11)$$

- **Reconstruction through Nonsampled Contourlet Transform**

The inverse NSCT on the fused coefficient of medical images $[H_{k,l}^F(i, j), L^F(i, j)]$ to get the final fused image F.

3.2. FLOW CHART OF MODIFIED METHOD

The technique for the modified multi-model image fusion can be expressed using the flow chart which is shown in Figure 14 which illustrates the fusion process for two multi-modal, i.e., CT and MRI images giving the fused image as a result.

The modified algorithm that is in the NSCT domain takes two input pictures and generate a composite picture. The basic condition in the modified framework is that all the source images must be registered to align the corresponding pixels. The main technique which used in the modified method is to combine two different techniques like the NSCT & the type-2 fuzzy logic. The block diagram of the proposed method is shown in Figure.12.

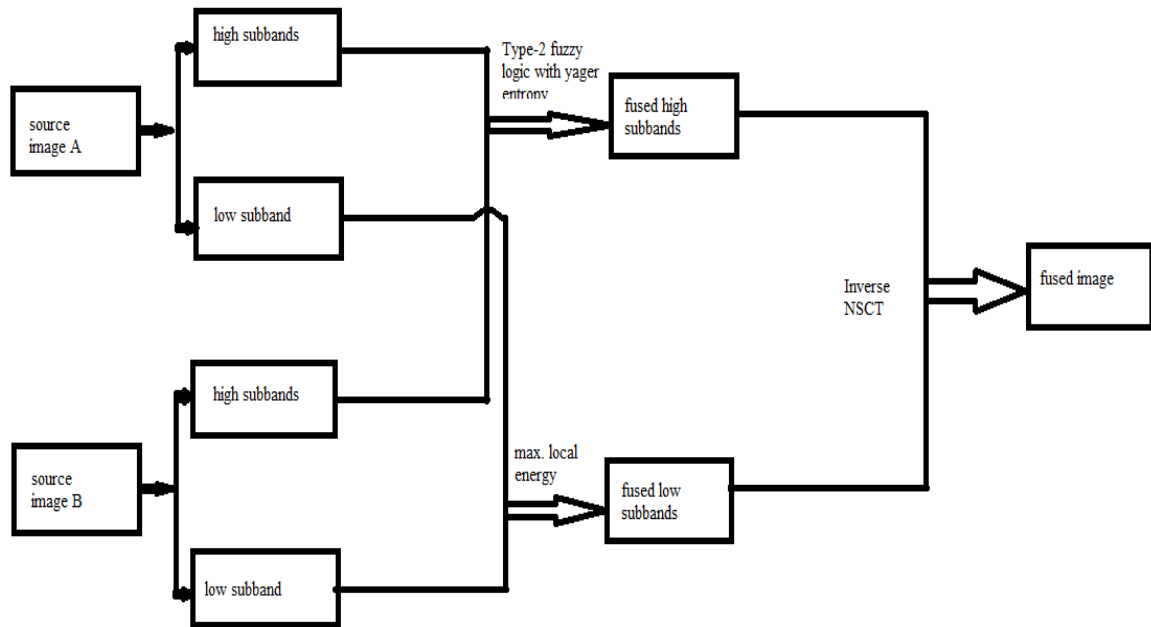

Figure 14 The block diagram of the modified image fusion.

3.3. STEPS FOR THE MODIFIED

- NSCT is utilizing for decomposing the input images A and B, through NSCT has obtained a series of high-frequency sub-bands at every level k and direction l and one low-frequency sub-band; that is, A: $\{H_{k,l}^A, L^A\}$. and B: $\{H_{k,l}^B, L^B\}$.
- The type-2 fuzzy logic with Yager entropy is high-frequencies fusion rule applied to high-frequency sub-images $H_{k,l}^A$ and $H_{k,l}^B$ to gotten $H_{k,l}^F$.

- The local energy based fusion rule is to apply low-frequency sub-band to a obtained component of low-frequency sub-band L^F .
- Use the reconstruct NSCT on the fused component $\{H_{k,l}^F, L^F\}$ to get the final fused image F.

CHAPTER 4

RESULT AND COMPARISON

In this chapter, details about the simulation of the modified method are presented, which is done using MATLAB. The result evaluation criteria are used for the calculation of modified method parameters and compare these parameters with the previous scheme[19]. This process is done in MATLAB.

4.1. RESULT EVALUATION CRITERIA

In this step, the selected quantitative criteria used in the objective analysis are described. It is well known that different image quality metrics measure the visual quality of images from different aspects, but none of them can directly measure the quality. In this paper, we consider both the visual representation and the quantitative assessment of the fused images. For evaluation of the modified fusion method, we have considered three separate fusion performance metrics as defined below:

4.1.1. Mutual Information (MI)

MI can demonstrate how much information the fused picture convey about the input pictures. MI b/w the fused and the input images are defined below: [15][16]

$$MI = MI_{AF} + MI_{BF} \quad (12)$$

MI_{AF} and MI_{BF} are the normalized mutual information b/w the fused picture and the input pictures A and B, MI_{AF} and MI_{BF} are calculated in equation (13) (14)

$$MI^{AF} = \sum_{f=0}^L \sum_{a=0}^L P^{AF}(a, f) \log_2 \left(\frac{P^{AF}(a, f)}{P^A(a)P^F(f)} \right) \quad (13)$$

and

$$MI^{BF} = \sum_{f=0}^L \sum_{b=0}^L P^{BF}(b, f) \log_2 \left(\frac{P^{BF}(b, f)}{P^B(b)P^F(f)} \right) \quad (14)$$

where a, b and $f \in [0, L]$. $p^A(a)$, $p^B(b)$ and $p^F(f)$ are the normalized grey level histograms of the input pictures and the fused pictures, respectively. $p^{AF}(a, f)$ and $p^{BF}(b, f)$ are the joint grey level histograms between the fused picture and the input picture A and B.

The greater the value of MI, than the better the fusion effect.

4.1.2. Edge-Based Similarity Measure (QAB/F)

$Q^{AB/F}$ which proposed by Xydeas and Petrović. [17] [18] It calculates the similarity b/w the edges transferred from the input images to the fused picture.

$$Q^{AB/F} = \frac{\sum_{i=1}^M \sum_{j=1}^N [Q^{AF}(i,j)W^A(i,j) + Q^{BF}(i,j)W^B(i,j)]}{\sum_{i=1}^M \sum_{j=1}^N [W^A(i,j) + W^B(i,j)]} \quad (15)$$

Where, $W^A(i,j)$ and $W^B(i,j)$ are corresponding gradient strengths for image A and B, and $Q^{AF}(i,j)$ and $Q^{BF}(i,j)$ are the edge strength and orientation preservation values at a location (i,j) for each source image.

Value of edge based similarity measure should be close to one, for the better-fused image.

4.1.3. Standard Deviation (STD)

The standard deviation can be used to estimate how widely spread the grey values in an image.[19]

$$STD = \left(\frac{1}{M \times N} \sum_{i=1}^M \sum_{j=1}^N (F(i,j) - \mu)^2 \right)^{1/2} \quad (16)$$

Where $F(i,j)$ = pixel value of the fused image at position (i,j) , and μ = mean value of the image.

Value of standard deviation should be larger for a good result.

4.2. SIMULATION RESULTS

The simulation of the modified method is done using MATLAB. In this utilize two source images, first is the MRI image, and the second one is a CT image, which is shown in the database in figure 15. Two source images were taken, fused them and the results obtained, and this result is compared with previous .scheme[19]

4.2.1. Images Database

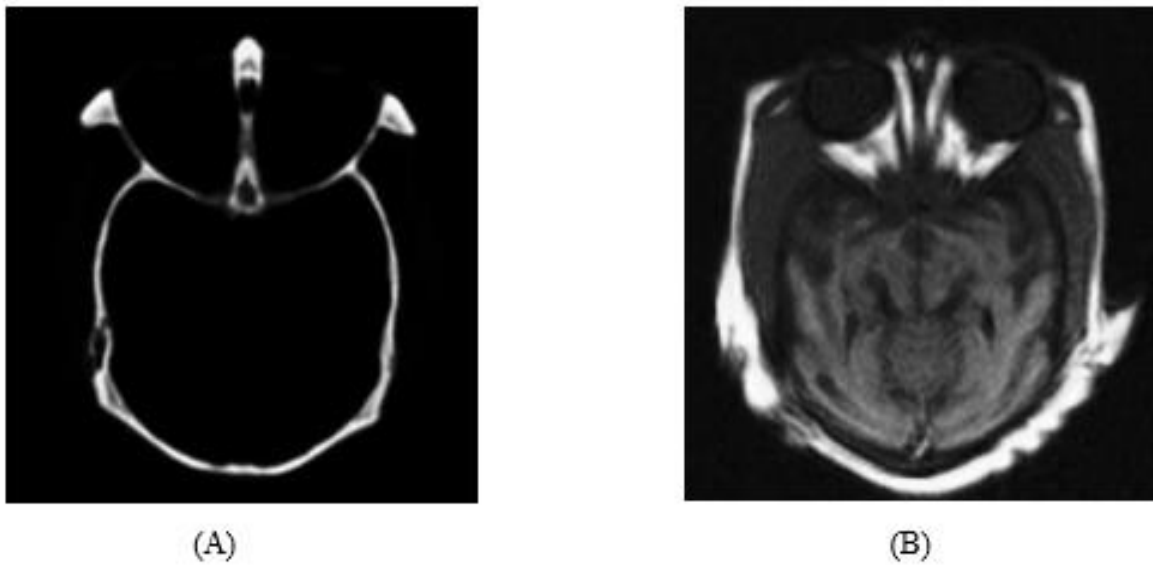

Figure 15 Source multimodal medical images: (A), (B) image group1 (CT and MRI)

A. The fusion of images using the previous scheme [19] result



Figure 16 previous scheme in [19]

In the previous scheme have two source images (MRI/CT), decompose these images by using the NSCT. Then High-frequencies picture combination based on the type-2 fuzzy logic is performed. Then invert NSCT used to fuse the image.

B. Image fusion using type 2 fuzzy logic with the Yager entropy

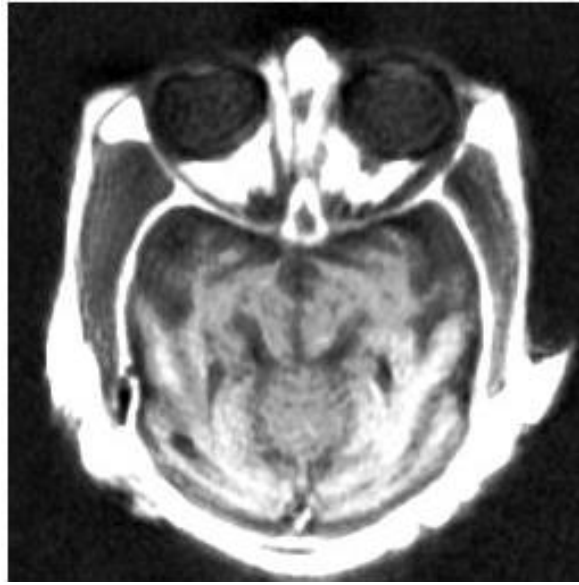

Figure 17 type 2 fuzzy logic with The Yager entropy

This modified scheme is similar to the previous scheme [19], but the difference at the high-frequency image fusion method, here use the Yager entropy method.

Table 1 Tabular comparison of Evaluation indices for fused medical images

In this table write result evaluation criteria parameters of a previous scheme [19] and modified method. These parameters are calculated in equations (12) to (16). This table shows a comparison of both methods.

Indices	Previous scheme[19]	Proposed method
MI	4.5619	4.8096
$Q^{AB/F}$	0.7859	0.9989
STD	60.8717	76.5824

From the above table 1, we can see that MI, QAB/F, STD value of the proposed method is greater than the previous scheme method [19].

CHAPTER 5

CONCLUSION AND FUTURE WORK

5.1. CONCLUSION

Multi-modal medical image fusion method based on type-2 fuzzy logic with the Yager entropy in the NSCT domain is modified. To overcome the limitations of the traditional fusion methods, a new couple of fusion rules is proposed, which are based on type-2 fuzzy logic with Yager entropy in the NSCT domain. For high-frequency image calculate type-2 Fuzzy Logic based the Yager entropy, and for low-frequency image calculate Local energy. These calculations are used to obtain more useful information data and improve the quality of the fused images. Experimental results demonstrate that the modified algorithm can enhance the details of the fused image and can improve the visual effect with less difference to the source images than several popular widely used fusion methods. In this modified method, I calculate Mutual Information (MI), Edge-Based Similarity Measure ($Q^{AB/F}$), Standard Deviation (STD) and compare these parameters with the previous scheme. [19] All parameters values improve with compared to the previous scheme, which is shown in table 1.

5.2. FUTURE WORK

Based on the examination completed in the present research, the following suggestions are, and it is useful to focus on the accompanying issue in future work.

- The modified technique can be reached out to other biomedical images.
- The modified technique can be reached out to other standard and general images to obtain a fused image, for example, clock image.
- The modified technique can be reached with PET and CT images. (Giesel et al. 2009)
- The modified technique can be reached by comparing the performance of other filter combinations for pyramidal and directional decomposition.
- In the present work, image fusion no specific type of noise was investigated but noise occurs. Multiple types of noise may corrupt an image. Therefore, the modified work

could be extended by designing image fusion algorithms that can remove the noise-infused image.

- Presence of blur is another common problem of imaging application. Presence of blur in an image makes the extraction of the important feature, difficult. Blur may occur simultaneously with different types of noise. Hence, deblurring is also an important task to increase the information content and quality of an image. Therefore, deblurring should also be incorporated with image fusion both in presence or absence of noise to increase the adaptive-ness of fusion algorithm.
- Throughout this thesis, it is accepted that the source pictures are recently enrolled. Therefore, the modified algorithm can be applied only on those images that are properly registered. In the future, work could be done on image registration, and it should be combined with image fusion. So, the fusion algorithms would not be limited to the registered images and can be applied on unregistered images.
- In the present work, the fusion process is limited for images only. In many fields of image processing like, surveillance and medical, series of images or video are being generated. Therefore, in those fields, the video frames need to be merged, which could be an interesting and challenging problem for future research.

REFERENCES

- [1] Shuto Li, Binyang, Jianwen Hu, "Performance comparison of different multi-resolution transforms for image fusion", 2011, ELSEVIER
- [2] Yang Xino-Hui, "Fusion Algorithm for Remote Sensing Image Based on Non sub sampled Contourlet Transform", 2008, Science Direct
- [3] John J. Lewis, R. Callaghan, "Pixel- and Region-based Image Fusion with Complex Wavelets", *Information Fusion*, 119–130, 2007.
- [4] Pohl et al. "Multi-sensor image fusion in remote sensing: concepts, methods and applications" *Int. J. of Remote sensing*, Vol. 19, No. 5, pp.823-854, 1998.
- [5] Ivan, W. Selesnick, Richard G. Baraniuk, and Kingsbury, N., "The Dual-Tree Complex Wavelet Transform", *IEEE Signal Processing Magazine*, Vol. 151, pp. 123-151, 2005.
- [6] K. Kannan, S. A. Perumal, "Optimal Decomposition Level of Discrete Wavelet Transform for Pixel Based Fusion of Multi-Focused Images,"
- [7] Arthur L.da Cunha, Jianping Zhou," The Non Subsampled Contourlet Transform: Theory Design,and Application",Vol nol 15, 2006, IEEE
- [8] Minh N.Doand Martin Vetterli. "The Contourlet Transform: An Efficient Directional Multiresolution Image Representation." December 2005, IEEE
- [9] C. W. de Silva. *Intelligent Control fizzy Logic Applications*. CRC Press, 1995.
- [10] D. Dubois and H. Prade. *Fuzzy Sets and Systems: Theory and Applications*. New York: Academic Press, 1980
- [11] J. S. R. Jang, C. T. Sun, and E. Mizutani. *Neuro-Fuzzy and Soft Computing*. Prentice Hall, 1997.
- [12] G. Klir, U. Clair, and Boyuan. *Fuzzy set theory, foundations and applications*. Prentice-Hall, 1988
- [13] J. M. Mendel and R. I. B. John. Type-II Fuzzy Sets Made Simple. *IEEE Trans. Fuzzy Syst.*, 10:117–127, 2002
- [14] N. N. Karnik and J. M. Mendel. Operations on Type-II Fuzzy Sets. *Fuzzy Sets and Systems*, 122:327–348, 2001
- [15] R. Yager. On the measure of fuzziness and negation. part i: Membership in the unit interval. *International Journal on General systems*, 5:221-229, 1979.

- [16] R. Yager. On the measure of fuzziness and negation. part ii: Lattice. Information and control, 44:236260, 1980.
- [17] P. Balasubramaniam and V. P. Ananthi, "Image fusion using intuitionistic fuzzy sets," Inf. Fusion, vol. 20, no. 15, pp. 21–30, 2014.
- [18] C. S. Xydeas and V. Petrović, "Objective image fusion performance measure," Electron. Lett., vol. 36, no. 4, pp. 308–309, 2000.
- [19] Yong yang, Yue Que, Shuying Huang, pan lin, Multimodal Sensor Medical Image Fusion Based on Type-2 Fuzzy Logic in NSCT Domain, IEEE SENSORS JOURNAL, VOL. 16, NO. 10, MAY 15, 2016.
- [20] Kiran parmar, Rahul Kher "A comparative analysis of multimodality Medical Image Fusion Methods", 2012 IEEE
- [21] R. Barani¹ and M. Sumathi "A New Adaptive-Weighted Fusion Rule for Wavelet based PET/CT Fusion" , 2016 International Journal of Signal Processing, Image Processing and Pattern Recognition
- [22] Arthur L. da Cunha, Jianping Zhou "The Nonsampled Contourlet Transform: Theory, Design, and Applications" , 2006 IEEE.
- [23] Jerry M. Mendel, Robert I. John, and Feilong Liu "Interval Type-2 Fuzzy Logic Systems Made Simple" , 2006 IEEE.

ORIGINALITY REPORT

16%

SIMILARITY INDEX

7%

INTERNET SOURCES

13%

PUBLICATIONS

10%

STUDENT PAPERS

PRIMARY SOURCES

1	mdpi.com Internet Source	2%
2	Yong Yang, Yingmei Zhang, Jiahua Wu, Luyi Li, Shuying Huang. "Multi-focus Image Fusion Based on a Non-Fixed-Base Dictionary and Multi-measure Optimization", IEEE Access, 2019 Publication	1%
3	S. Al-sharhan, F. Karray, W. Gueaieb, O. Basir. "Fuzzy entropy: a brief survey", 10th IEEE International Conference on Fuzzy Systems. (Cat. No.01CH37297), 2001 Publication	1%
4	ethesis.nitrkl.ac.in Internet Source	1%
5	Submitted to Visvesvaraya National Institute of Technology Student Paper	1%
6	Choi, Yoonsuk, Ershad Sharifahmadian, and Shahram Latifi. "Performance analysis of	1%