

A  
DISSERTATION REPORT  
ON  
**GAIN ENHANCEMENT OF CIRCULARLY POLARIZED  
SQUARE SLOT ANTENNA USING ARTIFICIAL  
MAGNETIC CONDUCTOR**

*is submitted as a partial fulfillment of the degree of*

**MASTER OF TECHNOLOGY**

*in*

**ELECTRONICS AND COMMUNICATION**

*to the*

**DEPARTMENT OF ELECTRONICS AND  
COMMUNICATION ENGINEERING**

*by*

**RAJAT ARORA**

**(2017PEC5160)**

*Under the guidance of*

**Prof. R.P. YADAV**



**Electronics & Communication Engineering Department**

**Malaviya National Institute of Technology, Jaipur**

**JULY 2019**



**DEPARTMENT OF ELECTRONICS & COMMUNICATION  
ENGINEERING  
MALAVIYA NATIONAL INSTITUTE OF TECHNOLOGY  
JAIPUR (RAJASTHAN) – 302017**

---

**Certificate**

This is to certify that the dissertation report entitled **Gain enhancement of circularly polarized square slot antenna using artificial magnetic conductor** submitted by **Rajat Arora (2017PEC5160)**, in the partial fulfillment of the Degree Master of Technology in **Electronics and Communication** of Malaviya National Institute of Technology, is the work completed by him under our supervision, and approved for submission during academic session 2018-2019.

Date:  
Place:

Prof. R.P.Yadav  
(Project Supervisor)  
Dept. of ECE  
MNIT Jaipur, India



**DEPARTMENT OF ELECTRONICS & COMMUNICATION  
ENGINEERING  
MALAVIYA NATIONAL INSTITUTE OF TECHNOLOGY  
JAIPUR (RAJASTHAN) – 302017**

---

**Declaration**

I, **Rajat Arora**, declare that this Dissertation titled as “**Gain enhancement of circularly polarized square slot antenna using artificial magnetic conductor**” and the work presented in it is my own and that, to the best of my knowledge and belief.

I confirm that the major portion of the report except the refereed works, contains no material previously published nor present a material which to be substantial extent has been accepted or the award of any other degree by university or other institute of higher learning. Wherever I used data (Theories, results) from other sources, credit has been made to that source by citing them (to the best of my knowledge). Due care has been taken in writing this thesis, errors and omissions are regretted.

Date :  
Place :

**Rajat Arora**  
ID : 2017PEC5160

## Acknowledgment

*I would like to thank all peoples who have helped me in this project, directly or indirectly.*

*I take immense pleasure in thanking of gratitude to my project supervisor **Prof. R.P. Yadav**, Professor, Malaviya National Institute of Technology (MNIT) Jaipur for being a source of inspiration and for timely guidance during the project. The supervision and support that he gave truly helped in the progression of my thesis. I am highly obliged to him for his valuable advices and moral support during research period.*

*I express my sincere gratitude to **Prof. D. Boolchandani** (Head of Department) for his support and guidance in this research work. Many thanks to committee members for their valuable comments and guidance in research exploration, without this guidance it was not possible to achieve these good results in this research work. I would like to thank Mr. Jaiverdhan, Phd Scholar for helping me and guiding me in my research work over time.*

*I am also very thankful to my friends Ram Gopal, Richa Verma, Kamal Singh Khatak, and Hardik Mathuriya for their valuable suggestions and discussion, which I had with them about this research work. They also help me in designing work of my project.*

*I would also like to thank Ministry of HRD, Government of India for its support to me to pursue my Masters in Electronics and Communication Engineering from Malaviya National Institute of Technology, Jaipur. This support provided me library, laboratory and other related infrastructure.*

*Rajat Arora*

## **Abstract**

An artificial magnetic conductor (AMC) using interdigital capacitors has been discussed. In this work, an 8 finger AMC is designed using CST software. Then, a circularly polarized slot antenna backed up with 8 fingers AMC and with two previously reported AMCs, one is conventional square patch and the other is 12 fingers AMCs is implemented and the gain performance of antenna with all three AMCs is compared. The Antenna with two previously proposed AMCs has a constant gain of 4.5 dB and 5.5 dB respectively across the circular polarization (CP) bandwidth. As the centre frequency of two previous AMCs are 2.5 GHz but in 8 fingers AMC the centre frequency is shifted to 2.68 GHz because of which antenna backed up with 8 fingers AMC has a constant gain of 8.5 dB across the CP bandwidth. Hence there is 72.72% and 54.54 % increase in the gain with respect to two previous AMCs respectively.

# Table of Contents

<b>Certificate</b> .....	i
<b>Declaration</b> .....	ii
<b>Acknowledgment</b> .....	iii
<b>Abstract</b> .....	iv
<b>List of Figures</b> .....	viii
<b>List of Abbreviations</b> .....	x
<b>List of Symbols</b> .....	xii
<b>Chapter 1 Introduction</b> .....	1
1.1 Background .....	1
1.2 Literature Survey .....	2
1.3 Dissertation Details .....	3
<b>Chapter 2 Antenna Theory</b> .....	4
2.1 Basics of antenna .....	4
2.2 Polarization .....	13
2.2.1 Types of polarization .....	14
2.3 Circular Polarization in antenna.....	15
2.3.1 Dual feed circularly polarized microstrip antenna.....	16
2.3.2 Single feed circularly polarized microstrip antenna .....	16
<b>Chapter 3 Metamaterials</b> .....	18
3.1 Metamaterials.....	18
3.2 Electromagnetic metamaterials .....	18
3.2.1 Negative refractive index metamaterials .....	19
3.2.2 Single negative metamaterials .....	20

3.2.3 Electromagnetic bandgap metamaterials .....	21
3.2.4 FSS based metamaterials .....	22
3.3 Artificial Magnetic Conductor .....	22
<b>Chapter 4 Simulation &amp; Results .....</b>	<b>25</b>
4.1 Simulation Software – CST .....	25
4.2 Antenna Configurations .....	26
4.3 Simulation Results And Discussion.....	27
4.3.1 Simulation Results of antenna backed up with conventional AMC .....	29
4.3.2 Simulation Results of antenna backed up with 12 fingers AMC.....	33
4.3.3 Simulation Results of antenna backed up with 8 fingers AMC.....	37
<b>CHAPTER-5 Conclusion.....</b>	<b>43</b>
<b>REFERENCES.....</b>	<b>44</b>

## List of Tables

Table 3. 1 Dimensions of the bidirectional CPW-fed CPSSA.....	27
Table 3. 2 Comparison table of antenna backed up with AMC's in terms of gain over CP bandwidth.....	42



## List of Figures

Figure 2. 1 Radiation pattern of a dipole antenna .....	7
Figure 2. 2 Radiation pattern of a dipole antenna in 3D .....	8
Figure 2. 3 Radiation pattern of a dipole antenna in 2D .....	9
Figure 2. 4 Lobe pattern of a dipole antenna in 3D .....	9
Figure 2. 5 Isotropic radiation pattern of a dipole antenna in 3D .....	10
Figure 2. 6 Half-power points on the major lobe .....	11
Figure 2. 7 Radiation pattern along with minor and major lobes .....	12
Figure 2. 8 Types of polarization .....	14
Figure 2. 9 Examples of dual fed CP patches .....	16
Figure 2. 10 Single fed patches .....	17
Figure 2. 11 Unit cells of three different AMCs [1] .....	23
Figure 3. 1 Left handed material and right handed material .....	20
Figure 3. 2 Unit cells of three different AMCs [1] .....	23
Figure 3. 3 Reflection Phase Diagram .....	24
Figure 4. 1 Configuration of the bidirectional CPW-fed CPSSA[1] .....	26
Figure 4. 2 Simulated Design of CPW-fed CPSSA .....	27
Figure 4. 3 Simulated Reflection Coefficient of the antenna .....	28
Figure 4. 4 Axial Ratio of CPSSA .....	28
Figure 4. 5 Maximum Gain Over Frequency .....	29
Figure 4. 6 :- Radiation Pattern of CPSSA antenna .....	29
Figure 4. 7 Unit cell of $AMC_{ref1}$ .....	30
Figure 4. 8 Reflection Phase Diagram of $AMC_{ref1}$ .....	30
Figure 4. 9 Square slot antenna backed up with $AMC_{ref1}$ .....	31
Figure 4. 10 Reflection coefficient of antenna with $AMC_{ref1}$ .....	31
Figure 4. 11 Maximum gain over frequency with $AMC_{ref1}$ .....	32
Figure 4. 12 Radiation Pattern of Antenna with $AMC_{ref1}$ .....	32
Figure 4. 13 Unit cell of 12 fingers AMC .....	33

Figure 4. 14 Reflection Phase Diagram of 12 fingers AMC.....	34
Figure 4. 15 Square slot antenna backed up with 12 fingers AMC .....	34
Figure 4. 16 Reflection coefficient of antenna with 12 fingers AMC .....	35
Figure 4. 17 Maximum gain over frequency with 12 fingers AMC .....	35
Figure 4. 18 Axial ratio with 12 fingers AMC.....	36
Figure 4. 19 Radiation Pattern of Antenna backed up with 12 fingers AMC.....	37
Figure 4. 20 Unit cell of AMC with 8 fingers.....	38
Figure 4. 21 Reflection Phase Diagram of AMC with 8 fingers.....	39
Figure 4. 22 Square slot antenna backed up with 8 fingers AMC .....	39
Figure 4. 23 Reflection coefficient of antenna with 8 fingers AMC .....	40
Figure 4. 24 Maximum gain over frequency with proposed AMC with 8 fingers .....	40
Figure 4. 25 Radiation Pattern of Antenna with 8 fingers AMC .....	41
Figure 4. 26 Axial Ratio with 8 finger AMC.....	41

## **List of Abbreviations**

CPSSA	-	Circularly Polarized Square Slot Antenna
CP	-	Circular Polarization
AMC	-	Artificial Magnetic Conductor
WLAN	-	Wireless local Area Network
EMT	-	Electro Magnetic Theory
RFID	-	Radio Frequency Identification
GNSS	-	Global Navigation Satellite System
Hz	-	Hertz
VSWR	-	Voltage Standing Wave Ratio
BW	-	Band Width
ERP	-	Effective Radiated Power
EIRP	-	Effective Isotropic Radiated Power
HPBW	-	Half Power Beam Width
FNBW	-	First Null Beam width
RF	-	Radio Frequency
UWB	-	Ultra wideband
DC	-	Direct Current
MEMS	-	Micro Electro Mechanical System
EM	-	Electro Magnetic
FSS	-	Frequency Selective Surface
PEC	-	Perfect Electric Conductor
TWT	-	Travelling Wave Tube

AR	-	Axial Ratio
dB	-	Decibals
2D	-	Two Dimensional
3D	-	Three Dimensional

## List of Symbols

A	-	Ampere
V	-	Voltage
$\mu\text{m}$	-	Micro Meter
mm	-	Milli Meter
dB	-	Decibels
GHz	-	Giga Hertz
C	-	Capacitance
$\Lambda$	-	Wavelength
F	-	Frequency
$\eta_e$	-	Efficiency
U	-	Radiation intensity

### 1.1 Background:-

In recent times, slot antenna has been used considerably to design circularly polarized antennas due to their advantages in obtaining high circular polarization bandwidth (BW), applications in multiband antenna etc. But, there applications are limited in a few areas because of their bidirectional radiation characteristics. Because of that it may limit its use in applications as wireless local area network (WLAN), radio frequency identification (RFID), and global navigation satellite systems (GNSS) [12]-[13]. There are some methods by using them we can convert its bidirectional radiations into unidirectional radiations for an eg. by Placing a metallic sheet as a reflector at a quarter wavelength separation below the slot radiator antenna, but unidirectional radiation can be achieved at the cost of a relatively higher profile, which is undesirable as systems are becoming large in size [14]. Then there comes the utilization of artificial magnetic conductor as (AMC) can be used to make circularly polarized slot antennas and dipole antennas unidirectional while maintaining low profile (less than  $\lambda/4$ ) property, because of their in-phase reflection property. However, the unit cell size of a typical AMC structure is about quarter to half wavelength because of which, results in an AMC reflector having prohibitively large overall size. then we can use high dielectric constant substrate to reduce the AMC size [15]. But then fabrication cost will be increased and the size is still not effectively reduced. Now to reduce its size, a miniaturized AMC loaded with lumped capacitors was proposed [6], and its performance primarily depends on the value of the capacitors. But unfortunately, this structure is polarization dependent, which means that, it cannot be used as a reflector in CP slot antennas. To make the structure polarization independent inter-digital capacitors are used in place of lumped capacitors to eliminate the ohmic losses added by the lumped ones and this inter-digital capacitors are placed in a symmetrical manner to get polarization independence. It also reduces the profile of the AMC. These inter-digital capacitors placed at 45 degree with respect to z-axis.

## 1.2 Literature Survey:-

The literature survey of various Artificial magnetic conductors and their uses in gain enhancement and unidirectional radiation by various researchers in previous years is shown below :

Jia-Yi Sze et al. 2008 [2]: In this paper a new wideband circularly polarized square slot antenna (CPSSA) with a coplanar waveguide (CPW) feed is presented. The proposed antenna features two inverted-L grounded strips around two opposite corners of the slot and a widened tuning stub introduced into the slot from the signal strip of the CPW. Broadside circular-polarization (CP) radiation can be easily obtained using a simple design procedure. Slot antenna's applications are limited in a few areas because of their bidirectional radiation characteristics. Because of that it may limit its use in applications as wireless local area network (WLAN), radio frequency identification (RFID), and global navigation satellite systems (GNSS).

H. Liu et al 2009 [4]: In this paper a miniaturised artificial magnetic conductor (AMC) using lumped capacitor is introduced. Simulated reflection phase data is presented, which proposes a unit cell periodicity. Its performance primarily depends on the value of the capacitors. Unfortunately, this structure is polarization dependent, which means that, it cannot be used as a reflector in CP slot antennas.

Jong Gyun Baek et al 2013 [3]: The design of a triple-band circularly polarized hexagonal slot antenna with L-shaped slits is presented in this study. An AMC conducting reflector is also used to enhance the antenna gain and to achieve unidirectional radiations. Unidirectional radiation and higher gain can be achieved at the cost of a relatively higher profile, which is undesirable as systems are becoming large in size.

Jianxing Li et al 2018 [5]: This paper investigates a low profile circularly polarized (CP) slot antenna with unidirectional radiation. The antenna includes a coplanar waveguide (CPW)-fed square slot radiator loaded by two L-shaped strips around two diagonal corners, underneath which is an artificial magnetic conductor (AMC) reflector with an air gap in between. The AMC reflector is polarization independent and miniaturized by using

lumped capacitors to accommodate sufficient unit cells. Structure present in this paper is polarization independent because of the symmetrical arrangement of the capacitors but as the no. of capacitors are more that's why the ohmic losses introduced by them high.

Jianxing Li et al 2018 [1]: A polarisation independent artificial magnetic conductor (AMC) miniaturised using interdigital capacitors is investigated. Its performance is analysed and compared with two other previously reported AMCs. Then, a circularly polarised square slot antenna (CPSSA) utilising the proposed AMC as a reflector is implemented, which achieves unidirectional radiation and low profile simultaneously. As such there is no limitation but the gain achieved using the AMC structure can be enhanced.

### **1.3 Dissertation Details:-**

As gain is an important parameter in the electromagnetics, the higher gain is desirable in any antenna. As in transmitting antenna, gain describes how well the antenna converts the input power to the radio waves in specific direction. In receiving antenna, gain specifies how good the antenna converts the radio waves into the electrical power. When there is no direction specified meaning there is no mention about transmitting or receiving antenna, gain is assumed to be the peak value of the gain in the direction of main lobe.

So as gain is one of the most important part of the antenna characteristics. We tried to improve it by considering the property of AMC, which states AMC provides 0 degree reflection in the range of +90 degree to -90 degree around the centre frequency. So we changed the centre frequency of the AMC to exactly the frequency of resonance of the circularly polarised square slot antenna (CPSSA). Because of that we were able to increase the gain of the antenna around 3 dB with respect to the previous best and we are also able to achieve polarisation independence.



#### 2.1 Basics of antenna:-

The radiation or launching the wave into the space is efficiently accomplished with the aid of conducting or dielectric structures called antennas (or) An antenna can be viewed as transducer capable of converting electrical power into electromagnetic waves and vice versa. The two main function of antenna is power radiation in the form of EM waves (power reception) and matching wave impedance in order to reduced reflection. An antenna can be connected to the electric circuit with the help of transmission line. A transmission line is a conductor which carries current over long distances with minimum losses. A transmission line conducting current with uniform velocity does not radiate power. It needed a time variant source to radiate power.

If the power has to be radiated even though the source is not time varying or conducting with uniform velocity, then the line has to be bent, truncated or even it can be terminated. If the current is changing with respect to time then by Maxwell's equations magnetic field will be created and it will radiate power. A waveguide is a structure which is bent or terminated to radiate energy. Waveguide is used for microwave transmission or reception.

Antennas are divided into various categories depending on:

1. Physical structure of the antenna
2. Frequency range of operation
3. Mode of application etc

#### Various parameters of the antenna are:-

##### (a). Impedance matching:

If the impedance value of the transmitter equals the impedance value of the receiver or vice versa, then it is termed as the impedance matching. At the condition of impedance matching maximum power is transmitted from the antenna or transmitter to the transmitter or receiver.

Necessity of impedance matching:

A resonant device is the one which gives better output at certain narrow band of frequencies. An antenna is a resonant device which delivers a better output when impedance is matched.

If antenna's impedance becomes equals to the free space impedance, then the antenna will radiate power effectively.

For a receiver antenna, antenna's output impedance equals to the input impedance of receiver amplifier.

For a transmitting antenna, antenna's input impedance becomes equals input impedance of transmitter amplifier along with line impedance.

**(b). VSWR & Reflected power:**

Standing wave is one in which transmitted and reflected waves meet each other. The ratio of the maximum voltage to the minimum voltage in a standing wave is known as VSWR (Voltage standing wave ratio). If the impedance of the antenna, transmission line and circuitry are not matched, then the antenna will not radiate power effectively, instead some of the power is reflected back and the standing wave will be created. VSWR indicate the impedance mismatching. As higher the impedance mismatch, the higher will be VSWR.

**(c). Radiation intensity (U):**

Power per unit solid angle is called radiation intensity (or) the emission of radiation to a maximum possible extent is the radiation intensity.

$$U = r^2 * P_{rad} \quad \dots(2)$$

Where U = radiation intensity

r = radial distance

$P_{rad}$  = radiated power.

Units are watts/steradian or watts/radian<sup>2</sup>

**(d). Directivity:**

The maximum directive gain (or) the ratio of maximum radiation intensity of the given antenna to the radiation intensity of isotropic antenna radiating the same total power is called as directivity (D).

$$D = \frac{\text{radiation intensity of the antenna in particular direction}}{\text{radiation intensity of isotropic antenna}} \quad \dots(3)$$

**(e). Antenna Efficiency:**

The ratio of radiated power of the antenna to the input power accepted by the antenna is termed as Antenna efficiency ( $\eta_e$ ).

$$\eta_e = P_{\text{rad}} / P_{\text{input}} \quad \dots(4)$$

Where  $P_{\text{rad}}$ = radiated power  
 $P_{\text{input}}$ =input power

**(f). Gain:**

The ratio of the radiation intensity in a given direction to the radiation intensity that would be obtained if the power accepted by the antenna were radiated isotropically is termed as Gain (G).

$$G = \eta_e * D \quad \dots(5)$$

Where  $\eta_e$ =efficiency  
 $D$ =directivity  
 $G$ =gain

The term antenna gain describes how much power is transmitted in the direction of maximum radiation to that of an isotropic source.

Gain is usually measured in dB.

Unlike directivity, antenna gain takes the losses that occur, also into account and hence focuses on the efficiency.

**(g). Near field & Far field:**

The field, which is the nearest to the antenna is called as near-field. It has an inductive effect and hence it is also known as inductive field, though it has some radiation components.

$$E \propto 1/r^2 \quad \dots(6)$$

Where  $E$ = electric field  
 $r$ =radial distance from antenna

The field, which is far from the antenna, is called as far-field. It is also called as radiation field, as the radiation effect is high in this area. Many of the antenna parameters along with the antenna directivity and the radiation pattern of the antenna are considered in this region only.

$$E \propto 1/r \quad \dots(7)$$

Where  $E$ = electric field  
 $r$ =radial distance from antenna

A wave-front is the locus of points characterized by propagation of positions of identical phase. The emission or reception of the wave-front of the antenna, which specifies the strength of the antenna, is termed as radiation.

**(h). Radiation pattern:**

The sketch used to represent the radiation is termed as radiation pattern. By seeing the radiation pattern function and directivity of the antenna can be found out. (or)

It is 3D plot of the radiation at far field (or)

3D plot of electric field at far field.

The diagram showing the radiation pattern is

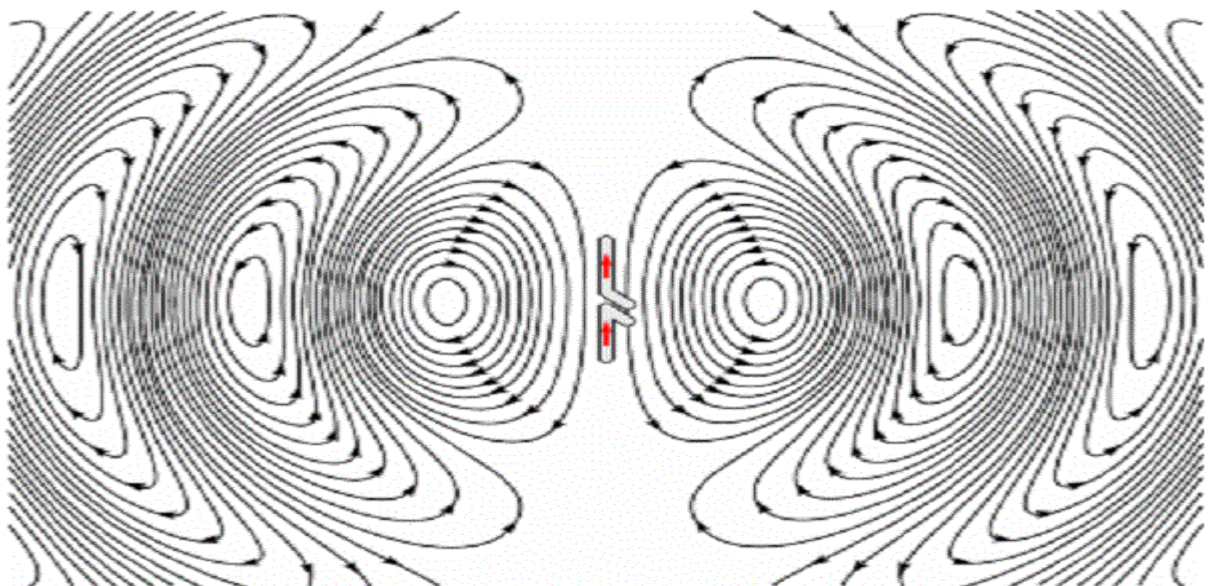

**Figure 2. 1 Radiation pattern of a dipole antenna[19]**

There are two types of patterns:

1. Radiation pattern
2. Power pattern

Both patterns are the combinations of two graphs. The definitions are as follows.

The above figure shows the radiation pattern of a dipole antenna. The energy being radiated is represented by the patterns drawn in a particular direction. The arrows represent directions of radiation. The radiation pattern may be field pattern or power pattern. The field patterns are plotted as a function of electric and magnetic fields and are plotted on logarithmic scale.

The power patterns are plotted as a function of square of the magnitude of electric and magnetic fields and are plotted on logarithmic or commonly on dB scale. Radiation pattern can be viewed in 3D or in 2D. In a 3D radiation pattern, radiation pattern is represented in spherical coordinates  $(r, \Theta, \phi)$ .

Where:  $r$  = the radial distance of point from origin

$\Theta$  = vertical angle to locate the point

$\phi$  = horizontal angle to locate the point

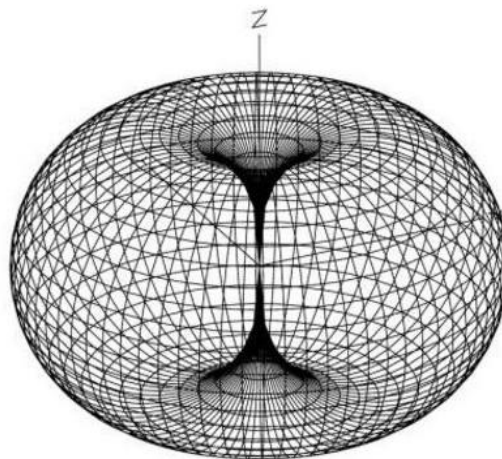

**Figure 2. 2 Radiation pattern of a dipole antenna in 3D [19]**

A 2D radiation pattern can be obtained from three dimensional pattern by dividing it into horizontal and vertical planes and these resultant patterns are known as Horizontal pattern and Vertical pattern respectively.

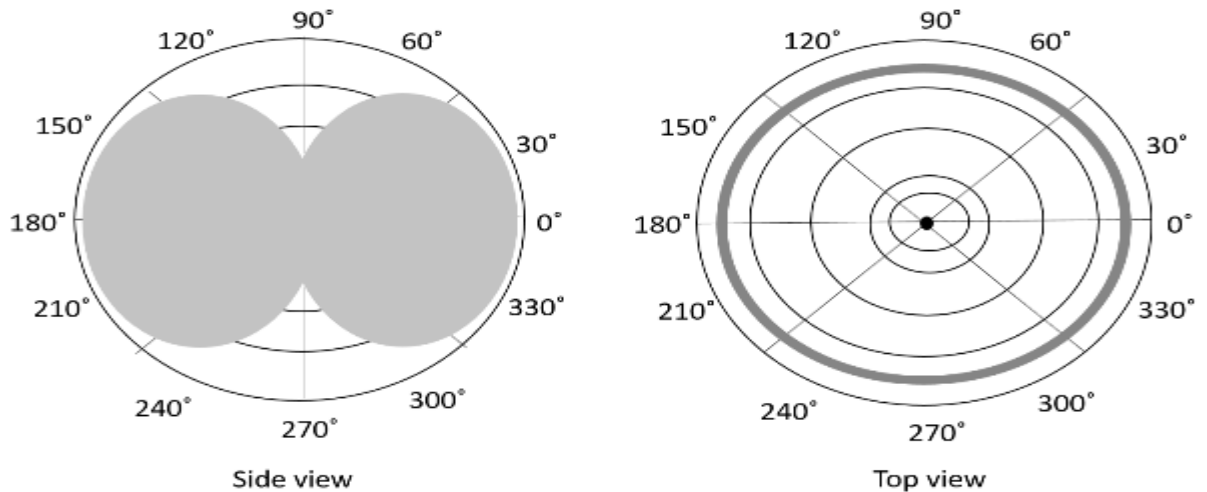

**Figure 2. 3 Radiation pattern of a dipole antenna in 2D [19]**

Lobe formation:

The shape of radiation pattern will be different for different antennas, which indicate the major and minor radiation areas, by which the radiation efficiency of the antenna is known. For better understanding, consider the radiation pattern of dipole antenna shown in below figure.

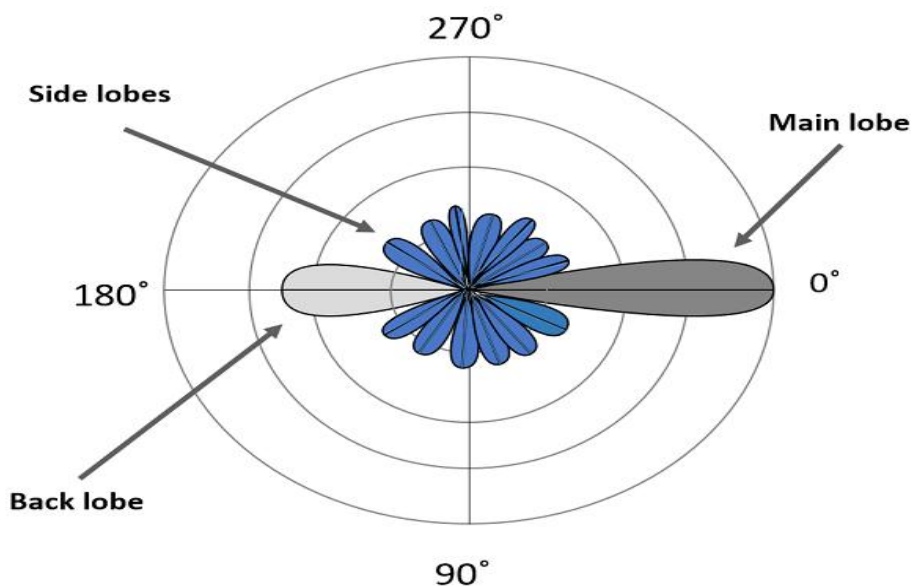

**Figure 2. 4 Lobe pattern of a dipole antenna in 3D [19]**

Here, the radiation pattern has main lobe, side lobes and back lobe. The major part of the radiated field, which covers a larger area, is the main lobe or major lobe. This is the

portion where maximum radiated energy exists. The direction of this lobe indicates the directivity of the antenna.

The other parts of the pattern where the radiation is distributed side wards are known as side lobes or minor lobes. These are the areas where the power is wasted. There is other lobe, which is exactly opposite to the direction of main lobe. It is known as the back lobe, which is also a minor lobe. A considerable amount of energy is wasted even here.

#### Isotropic radiation:

The radiation from a point source, radiating uniformly in all directions, with same intensity regardless of the direction of measurement is called isotropic radiation. The point source is an example of isotropic radiator. However, this isotropic radiation is practically impossible, because every antenna radiates its energy with some directivity. The isotropic radiation is nothing but Omni-directional radiation. It has a doughnut-shaped pattern when viewed in 3D and a figure-of-eight pattern when viewed in 2D.

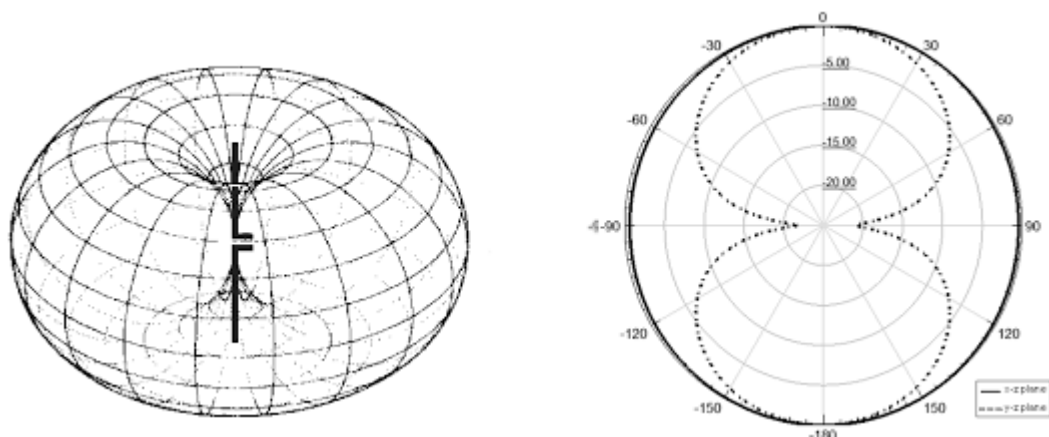

**Figure 2. 5 Isotropic radiation pattern of a dipole antenna in 3D [19]**

Gain of isotropic antenna is 1 (0 dB).

#### (i). Effective Radiated Power:

If the radiated power is calculated by taking half-wave dipole as the reference, rather than an isotropic antenna, then it can be termed as ERP (Effective Radiated Power).

$$\text{ERP (dBW)} = \text{EIRP (dBW)} - 2.15\text{dBi} \quad \dots(8)$$

Where ERP= effective radiated power  
EIRP=effective isotropic radiated power

If EIRP (Effective isotropic Radiated Power) is known, then ERP can be calculated from formula given above.

**(j). Beam width:**

Beam width is the aperture angle from where most of the power is radiated. The two main considerations of this beam width are Half Power Beam Width (HPBW) and First Null Beam Width (FNBW).

(i) Half-Power Beam Width:

The angular separation, in which the magnitude of the radiation pattern decreases by 50% (or -3dB) from the peak of the main beam, is the Half Power Beam Width.

In other words, Beam width is the area where most of the power is radiated, which is the peak power. Half power beam width is the angle in which relative power is more than 50% of the peak power, in the effective radiated field of the antenna.

When a line is drawn between radiation pattern's origin and the half power points on the major lobe, on both the sides, the angle between those two vectors is termed as HPBW, half power beam width.

This can be understood with the help of the following diagram.

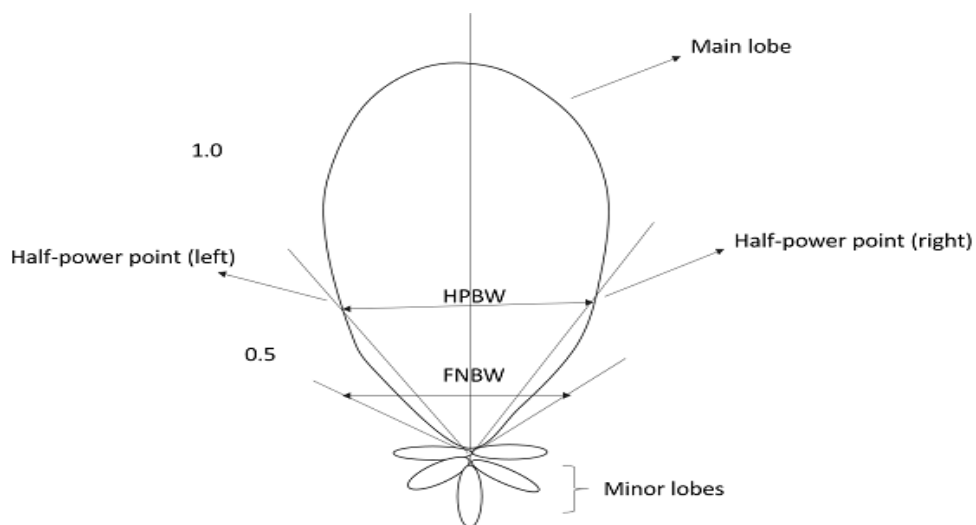

**Figure 2. 6 Half-power points on the major lobe[19]**



The above figure shows half-power points on the major lobe and HPBW.

The mathematical expression for half power beam width is–

$$\text{Half power Beam width} = 70\lambda/D \quad \dots(9)$$

Where,  $\lambda$  = wavelength ( $\lambda$  = velocity of light/frequency).

D = Diameter.

The unit of HPBW is radians or degrees.

(ii) First Null Beam Width:

The angular span between the first pattern nulls adjacent to the main lobe, is called as the First Null Beam Width. Simply, FNBW is the angular separation, quoted away from the main beam, which is drawn between the null points of radiation pattern, on its major lobe. Draw tangents on both sides starting from the origin of the radiation pattern, tangential to the main beam. The angle between those two tangents is known as First Null Beam Width (FNBW).

This can be better understood with the help of the following diagram.

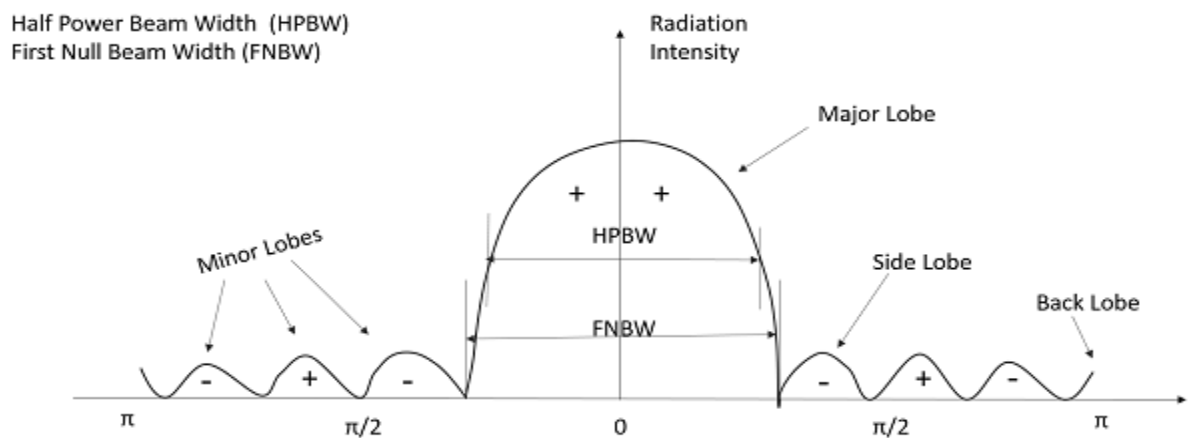

Antenna Parameters illustrated over a typical directional antenna radiation Pattern

**Figure 2. 7 Radiation pattern along with minor and major lobes[19]**

The above image shows the half power beam width and first null beam width, marked in a radiation pattern along with minor and major lobes.

### **(k). Effective Length & Effective Area:**

Antenna Effective length is used to determine the polarization efficiency of the antenna. The Effective length is the ratio of the magnitude of voltage at the open terminals of the receiving antenna to the magnitude of the field strength of the incident wave front, in the same direction of antenna polarization.

When an incident wave arrives at the antenna's input terminals, this wave has some field strength, whose magnitude depends upon the antenna's polarization. This polarization should match with the magnitude of the voltage at receiver terminals.

The mathematical expression for effective length is –

$$L_e = V_{oc} / E_i \quad \dots(10)$$

Where:-  $L_e$  = effective length.

$V_{oc}$  = open-circuit voltage.

$E_i$  = field strength of the incident wave.

Effective area is the area of the receiving antenna, which absorbs most of the power from the incoming wave front, to the total area of the antenna, which is exposed to the wave front.

The whole area of an antenna while receiving faces the incoming electromagnetic waves, whereas only some portion of the antenna, receives the signal, known as the effective area.

Only some portion of the received wave front is utilized because some portion of the wave gets scattered while some gets dissipated as heat. Hence, without considering the losses, the area, which utilizes the maximum power obtained to the actual area, can be termed as effective area.

Effective area is represented by  $A_{eff}$ .

## **2.2 Polarization:-**

When a wave is travelling in space the property that describes its electric field rotation at a fixed point as a function of time is called wave polarization. It is a parameter which remains constant over the antenna main beam but may vary in the minor loops. Since the

electric and magnetic field vectors are always related according to Maxwell's equation, it is enough to specify the polarization of one of them. The polarization plane is the plane containing the electric and magnetic field vectors and it is always perpendicular to the plane of propagation. The contour drawn by the tip of the electric field vector describes the wave polarization. This contour can be an ellipse, circle or a line. The polarization direction is assumed in the direction of the main beam unless otherwise stated.

Polarization is a very important factor in wave propagation between the transmitting and receiver antennas. Having the same kind of polarization and sense is important so that the receiving antenna can extract the signal from the transmitted wave. Maximum power transfer will take place when the receiving antenna has the same direction, axial ratio, spatial orientation and the same sense of polarization as incident wave, otherwise there will be polarization mismatch. If polarization mismatch occurs it will add more losses. Polarization is very important when considering wave reflection.

### 2.2.1 Types of polarization:-

There are three types of polarization

1. Linear polarization
2. Elliptical Polarization
3. Circular Polarization

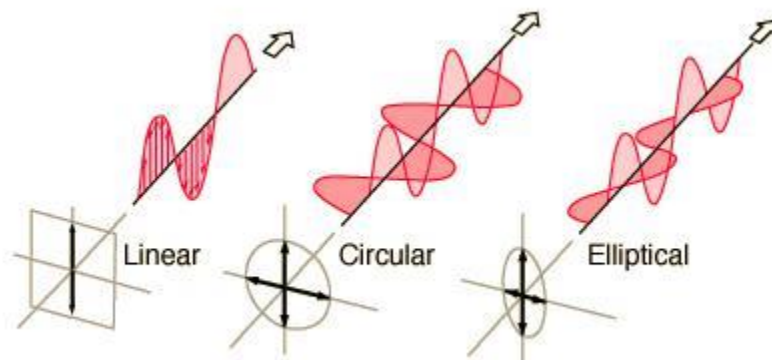

**Figure 2. 8** Types of polarization

Elliptical polarization is the general polarization state. When the tip of the electric field vector traces an ellipse at a fixed point in space, then it is elliptically polarized. And this happens when the electric field x and y components don't have the same magnitude and a phase difference is  $90^\circ$ .

The sense of polarization of the elliptical polarization depends on the direction of rotation of the electric field vector, it is determined from the phase leading component to the phase lagging component in a direction away from the observer. If the electric field vector rotates clockwise, it is right-hand elliptical polarization and if the electric field vector rotates counter clockwise; it is left-hand elliptical polarization.

When the tip of the electric field vector moves along a line in space, then it is linearly polarized. And this happens when the electric field has only one component.

When the tip of the electric field vector traces a circle at a fixed point in space, then it is circularly polarized. And this happens when the electric field x and y components have the same magnitude and the phase difference between them is odd multiples of  $90^\circ$ .

The sense of polarization of the circular polarization depends on the direction of rotation of the electric field vector from the phase leading component to the phase lagging component in a direction away from the observer. If the electric field vector rotates clockwise, it is right-hand circular polarization and if the electric field vector rotates counter clockwise, it is left-hand circular polarization.

### **2.3 Circular Polarization in antenna:-**

Nowadays circular polarization is very important in the antenna design, it eliminates the importance of antenna orientation in the plane perpendicular to the propagation direction, it gives much more flexibility to the angle between transmitting & receiving antennas, also it enhances weather penetration. It is used in a bunch of commercial and military applications. However it is difficult to build good circularly polarized antenna. For circular polarization to be generated in microstrip antenna two modes equal in magnitude and  $90^\circ$  out of phase are required. Microstrip antenna on its own doesn't generate circular polarization; subsequently some changes should be done to the patch antenna to be able to generate the circular polarization. The circular microstrip patch antenna's lowest mode is the  $TM_{11}$ , the next higher order mode is the  $TM_{21}$  which can be driven to produce

circularly polarized radiation. Circularly polarized microstrip antennas can be classified according to the number of feeding points required to produce circularly polarized waves. The most commonly used feeding techniques in circular polarization generation are dual feed and single feed.

### 2.3.1 Dual feed circularly polarized microstrip antenna:-

As  $90^\circ$  phase shift between the fields in the microstrip antenna is a prerequisite for having circular polarization, dual feed is an easy way to generate circular polarization in microstrip antenna. The two feed points are chosen perpendicular to each other as shown in Figure. With the help of external polarizer the microstrip patch antenna is fed by equal in magnitude and orthogonal feed. Dual feed can be carried out using quadrature hybrid, ring hybrid, Wilkinson power divider, T-junction power splitter or two coaxial feeds with physical phase shift  $90^\circ$ .

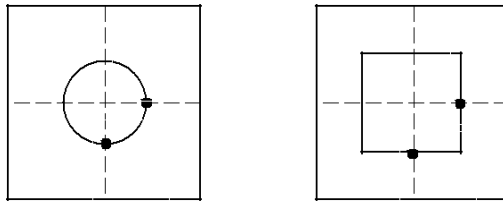

**Figure 2. 9 Examples of dual fed CP patches**

### 2.3.2 Single feed circularly polarized microstrip antenna:-

Single fed microstrip antennas are simple, easy to manufacture, low cost and compact in structure as shown in Figure. It eliminates the use of complex hybrid polarizer, which is very complicated to be used in antenna array. Single fed circularly polarized microstrip antennas are considered to be one of the simplest antennas that can produce circular polarization. In order to achieve circular polarization using only single feed two degenerate modes should be excited with equal amplitude and  $90^\circ$  difference. Since basic shapes microstrip antenna produce linear polarization there must be some changes in the patch design to produce circular polarization. Perturbation segments are used to split the field into two orthogonal modes with equal magnitude and  $90^\circ$  phase shift. Therefore the circular polarization requirements are met.

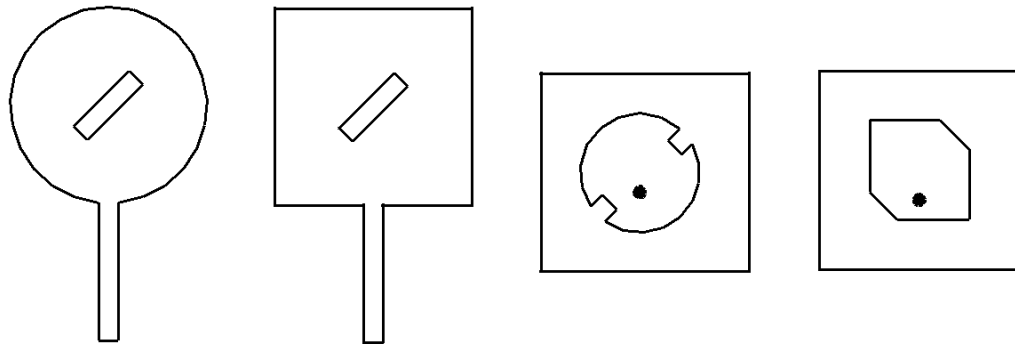

**Figure 2. 10** Single fed patches

The dimensions of the perturbation segments should be tuned until it reach an optimum value at the design frequency.

### 3.1 Metamaterials:-

A Metamaterial is a material engineered to have a property that is not found in naturally occurring materials. They are made from combination of multiple elements fashioned from composite materials such as metals and plastics. The materials are usually arranged in repeating patterns, at scales that are smaller than the wavelengths of the phenomena they influence. Metamaterials derive their properties not from the properties of the base materials. Their precise shape, geometry, size, orientation and arrangement gives them their smart properties capable of manipulating electromagnetic waves: by blocking, absorbing, enhancing, or bending waves, to achieve benefits that go beyond what is possible with conventional materials.

Appropriately designed metamaterials can affect waves of electromagnetic radiation or sound in a manner not observed in bulk materials. Those that exhibit a negative index of refraction for particular wavelengths have attracted significant research. These materials are known as negative index metamaterials.

Potential applications of metamaterials are diverse and include optical filters, medical devices, remote aerospace applications, sensor detection and infrastructure monitoring, smart solar power management, high frequency battlefield communication and lenses for high-gain antennas, improving ultrasonic sensors, and even shielding structures from earthquakes. Metamaterials offer the potential to create superlenses.

### 3.2 Electromagnetic metamaterials :-

An electromagnetic metamaterial affects electromagnetic waves that interact with its structural features, which are smaller than the wavelength. To behave as a homogeneous material accurately described by an effective refractive index, its features must be much smaller than the wavelength.

For microwave radiation, the features are on the order of millimeters. Microwave frequency metamaterials are usually constructed as arrays of electrically conductive

elements (such as loops of wire) that have suitable inductive and capacitive characteristics. One microwave metamaterial uses the split-ring resonator.

Photonic metamaterials, nanometer scale, manipulate light at optical frequencies. To date, subwavelength structures have shown only a few, questionable, results at visible wavelengths. Photonic crystals and frequency-selective surfaces such as diffraction gratings, dielectric mirrors and optical coatings exhibit similarities to subwavelength structured metamaterials. However, these are usually considered distinct from subwavelength structures, as their features are structured for the wavelength at which they function and thus cannot be approximated as a homogeneous material. However, material structures such as photonic crystals are effective in the visible light spectrum. The middle of the visible spectrum has a wavelength of approximately 560 nm (for sunlight). Photonic crystal structures are generally half this size or smaller, that is <280 nm.

Plasmonic metamaterials utilize surface plasmons, which are packets of electrical charge that collectively oscillate at the surfaces of metals at optical frequencies.

Frequency selective surfaces (FSS) can exhibit subwavelength characteristics and are known variously as artificial magnetic conductors (AMC) or High Impedance Surfaces (HIS). FSS display inductive and capacitive characteristics that are directly related to their subwavelength structure.

Electromagnetic metamaterials are divided into following parts.

### **3.2.1 Negative refractive index metamaterials :-**

In negative-index metamaterials (NIM), both permittivity and permeability are negative, resulting in a negative index of refraction. These are also known as double negative metamaterials or double negative materials (DNG). Other terms for NIMs include "left-handed media", "media with a negative refractive index", and "backward-wave media".

$$n = \pm\sqrt{\epsilon\mu} \quad \dots(3.1)$$

metamaterials have  $\epsilon < 0$  and  $\mu < 0$ . Because the product of both is positive,  $n$  is real. Under such circumstances, it is necessary to take the negative square root for  $n$ .



In optical materials, if both permittivity  $\epsilon$  and permeability  $\mu$  are positive, wave propagation travels in the forward direction. If both  $\epsilon$  and  $\mu$  are negative, a backward wave is produced. If  $\epsilon$  and  $\mu$  have different polarities, waves do not propagate.

Metamaterials with negative  $n$  have some interesting properties:

Snell's law ( $n_1 \sin \theta_1 = n_2 \sin \theta_2$ ), but as  $n_2$  is negative, the rays are refracted on the same side of the normal on entering the material.

The time-averaged Poynting vector is antiparallel to phase velocity. However, for waves (energy) to propagate, a  $-\mu$  must be paired with a  $-\epsilon$  in order to satisfy the wave number dependence on the material parameters .

Negative index of refraction derives mathematically from the vector triplet  $\mathbf{E}$ ,  $\mathbf{H}$  and  $\mathbf{k}$ .

For plane waves propagating in electromagnetic metamaterials, the electric field, magnetic field and wave vector follow a left-hand rule, the reverse of the behavior of conventional optical materials.

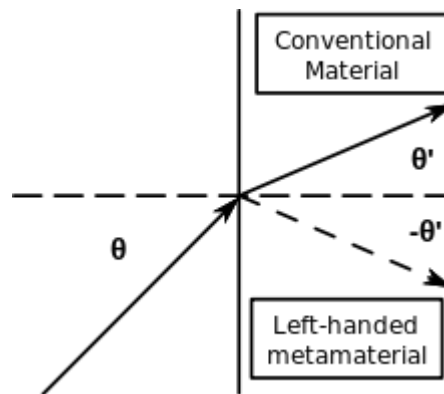

**Figure 3. 1 Left handed material and right handed material**

### 3.2.2 Single negative metamaterials :-

Single negative (SNG) metamaterials have either negative relative permittivity ( $\epsilon_r$ ) or negative relative permeability ( $\mu_r$ ), but not both. They act as metamaterials when combined with a different, complementary SNG, jointly acting as a DNG.

Epsilon negative media (ENG) display a negative  $\epsilon_r$  while  $\mu_r$  is positive. Many plasmas exhibit this characteristic. For example, noble metals such as gold or silver are ENG in the infrared and visible spectrums.

Mu-negative media (MNG) display a positive  $\epsilon_r$  and negative  $\mu_r$ . Gyrotropic or gyromagnetic materials exhibit this characteristic. A gyrotropic material is one that has been altered by the presence of a quasistatic magnetic field, enabling a magneto-optic effect.

### **3.2.3 Electromagnetic bandgap metamaterials :-**

Electromagnetic bandgap metamaterials (EBG or EBM) control light propagation. This is accomplished either with photonic crystals (PC) or left-handed materials (LHM). PCs can prohibit light propagation altogether. Both classes can allow light to propagate in specific, designed directions and both can be designed with bandgaps at desired frequencies. The period size of EBGs is an appreciable fraction of the wavelength, creating constructive and destructive interference.

PCs have periodic inclusions that inhibit wave propagation due to the inclusions' destructive interference from scattering. The photonic bandgap property of PCs makes them the electromagnetic analog of electronic semi-conductor crystals.

EBGs have the goal of creating high quality, low loss, periodic, dielectric structures. An EBG affects photons in the same way semiconductor materials affect electrons. PCs are the perfect bandgap material, because they allow no light propagation. Each unit of the prescribed periodic structure acts like one atom, albeit of a much larger size.

EBGs are designed to prevent the propagation of an allocated bandwidth of frequencies, for certain arrival angles and polarizations. Various geometries and structures have been proposed to fabricate EBG's special properties. In practice it is impossible to build a flawless EBG device.

EBGs have been manufactured for frequencies ranging from a few gigahertz (GHz) to a few terahertz (THz), radio, microwave and mid-infrared frequency regions. EBG application developments include a transmission line and several different types of low gain antennas.

### **3.2.4 FSS based metamaterials:-**

Frequency selective surface-based metamaterials block signals in one waveband and pass those at another waveband. They have become an alternative to fixed frequency metamaterials. They allow for optional changes of frequencies in a single medium, rather than the restrictive limitations of a fixed frequency response.

There are other types of metamaterials are also there, those are:- double positive metamaterials, Bi-isotropic and bianisotropic metamaterials, elastic, acoustic, structural, hall metamaterials and non linear metamaterials etc.

### **3.3 Artificial Magnetic Conductor:-**

AMC is an example of Electromagnetic metamaterials. An electromagnetic metamaterial affects electromagnetic waves that interact with its structural features, which are smaller than the wavelength. Metamaterials derive their properties not from the base materials but from their newly designed periodical structure, precise shape, geometry and arrangement gives them their properties to manipulate EM waves like doesn't found in conventional materials. Examples of this types of materials are:- FSS, Photonic crystal, AMC etc.

A unipolar compact electromagnetic bandgap structures, first presented by Itoh et al.[16] is called as AMC structure. An AMC is an EBG that is intentionally structured with a magnetic conductor surface for an allotted, but defined range of frequencies. AMC often emerged from an engineered periodic dielectric base along with metallization patterns designed for microwave and radio frequencies. AMC designed to have a set of frequencies over which EM surface waves and currents are not allowed to propagate. These materials are then both beneficial and practical as antenna ground planes, small flat signal processing filters. The metallization Since the introduction of the artificial magnetic conductor (AMC), also known as high impedance surface, a new methodology to design low profile high performance antennas has been researched. Significance of AMC is it will give in-phase reflection characteristics. The structure of AMCs consists of periodic structure of unit cells. AMCs are widely used to replace the traditional PEC reflector to realize unidirectional radiation and low profile at the same time. However, the unit cell size of a typical AMC structure is usually quarter to

half wavelength, which results in large, size. So to reduce the size of AMC a high dielectric constant substrate was used but it will increase the fabrication cost. So to overcome this limitation miniaturized AMCs using lumped and inter-digital capacitor were developed.

Periodic metallic arrays printed on grounded dielectric substrates and connected to the ground plane known as high impedance surfaces. Due to the high surface impedance the magnetic field tangential to the surface vanishes, i.e. It fully reflects incident waves with a zero degrees reflection phase.

Three different unit cells of AMC is shown as follows:

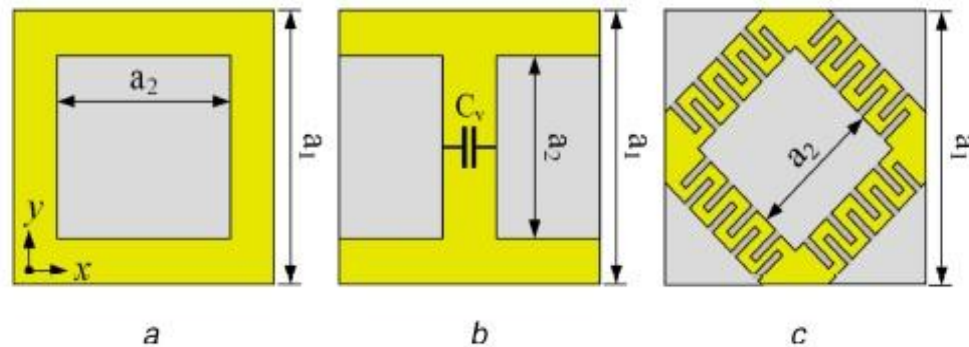

**Figure 3. 2 Unit cells of three different AMCs [1]**

We will discuss about the AMCs present in above figure2.3 (a), and (c) in the next chapters.

AMC present in figure2.3 (b) has a lumped capacitor, due to which losses are in that case. Characteristics of AMCs are represented by a diagram called “Reflection Phase Diagram”.

Reflection phase diagram signifies the ideal operating bandwidth for the use of the particular AMC structure.

The following figure represents the example of a random Reflection phase diagram of an AMC structure. Which has a centre frequency of 2.5 GHz.

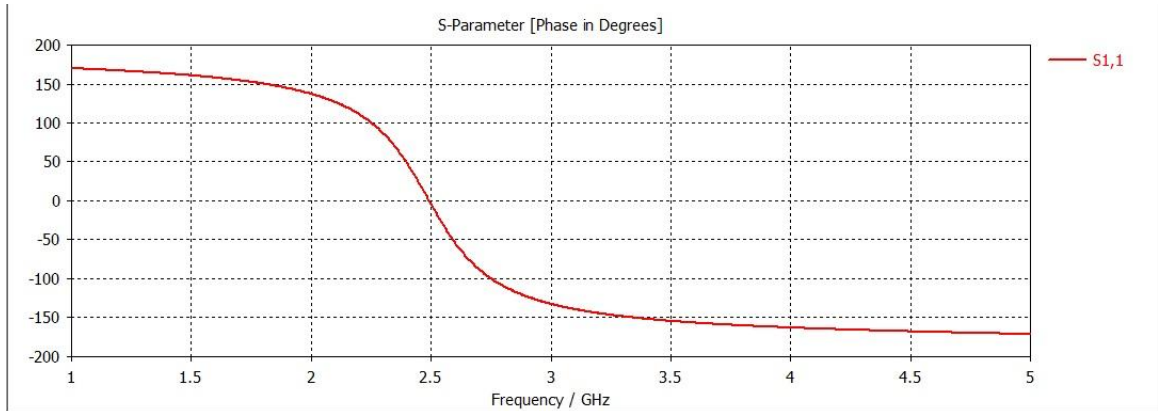

**Figure 3. 3 Reflection Phase Diagram**

For example:- In above diagram AMC will provide 0 degree phase at 2.5 GHz frequency and its bandwidth will be between +90 deg to -90 deg. Meaning it will provide the in phase reflection around 2.5 GHz frequency.

For the above AMC with inter-digital capacitor, capacitance can be calculated with this formula.

$$C = \frac{(\varepsilon+1)*l*[(n-3)*0.089+0.10]}{w} \text{ pF/Cm} \quad \dots(3.2)$$

Where :-  
 $\varepsilon$ = dielectric constant  
 $w$ =finger base width (cm)  
 $l$ =finger length (cm)  
 $n$ = number of fingers

so from the above equation it is clear that we can change the capacitance of the inter digital capacitor by changing the dimension of the finger length and finger width as well as the no of fingers.

As we all know:- capacitance is indirectly proportional to the frequency.

So by changing the capacitance of the inter digital capacitor we can change the centre frequency of the AMC.

### 4.1 Simulation Software – CST

The software used to perform all the simulations is CST Studio Suite. CST is used in leading industries across fields such as automotive, communication, defense, electronics, energy, and healthcare, in order to design, analyze and optimize performance, reliability, signal/power integrity. Among the devices that CST Studio Suite has been used to simulate are couplers, filters, connectors, antennas, travelling wave tube (TWT) etc. Some of CST's features are:

1. It can model true 3D metallic structures in multiple dielectric layers in open, closed or periodic boundary conditions.
2. High efficiency high accuracy and low cost electromagnetic simulation tool on PCs with window based graphics.
3. Automatic generation of non-uniform mesh with rectangular and triangular cells.
4. Can model structures with finite ground planes and differential feed structures.
5. Accurate modeling of true 3D metallic structures and metal thickness.
6. It can be called as Efficient matrix solver.
7. 3D and 2D display of current distribution, radiation patterns and far field.
8. CST can be used to design and simulate filters also.
9. CST gives more accurate results rather than HFSS.

For our purposes it is very powerful tool as it allows for ease of design and accurate simulation results. The results obtained for each patch are 2D view of patch, 3D view of patch, RL curve, Directivity, gain, and other such parameters.

There is one more software called HFSS, which can also be used to carry out all the simulations which is required by ourselves.

## 4.2 Antenna Configurations:-

There are three different AMC structures are simulated and the results of there reflection phase diagram as well as the other results with the same antenna are compared with each other.

Firstly, we have simulated “Bidirectional CPW-fed CPSSA (circular polarization square slot antenna)” Based on Reference [1]. Fig. 1 shows the geometry of the proposed Antenna, which consists of a rectangular ground plane with dimension of  $L$  length and  $W$  width and a square slot in the centre of ground. Two inverted L - shape grounded strips around the corners.

The proposed antenna is designed on an FR4 material substrate with permittivity of 4.4, and a thickness ( $t$ ) of 0.74 mm. The antenna is fed by a 50- ohm CPW having a single strip of width  $W_f = 1.8\text{mm}$  and two identical gaps of width  $g = 1\text{mm}$ . Two parameters,  $W_{f1}$  and  $g$  are adjusted to produce 50 ohm impedance for feeding of the antenna. The CP operation of the proposed antenna is chiefly related to the two grounded inverted-L strips inserted around the corners of the square slot.

The dimensions of proposed antenna in Fig. are listed in Table 1.

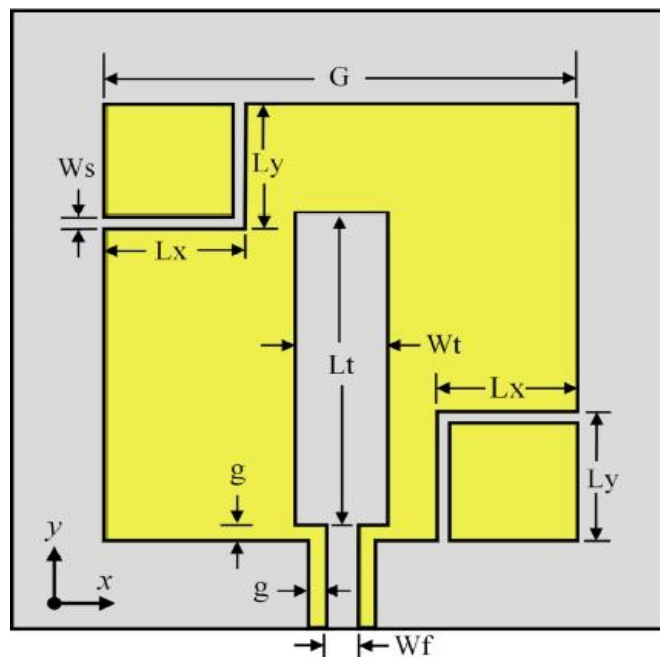

**Figure 4. 1 Configuration of the bidirectional CPW-fed CPSSA[1]**

L	60
G	43
Lx	13
Ly	13
Ws	1
Wf	1.8
Wt	14
Lt	33.9
g	1
h1	0.74

**Table 4. 1 Dimensions of the bidirectional CPW-fed CPSSA**

### 4.3 Simulation Results And Discussion:-

The antenna with dimensions in Table 1 has been fabricated on an FR4 substrate with a loss tangent of 0.02, permittivity of 4.4.

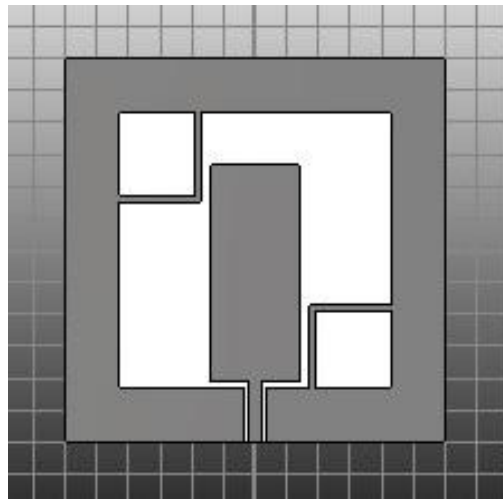
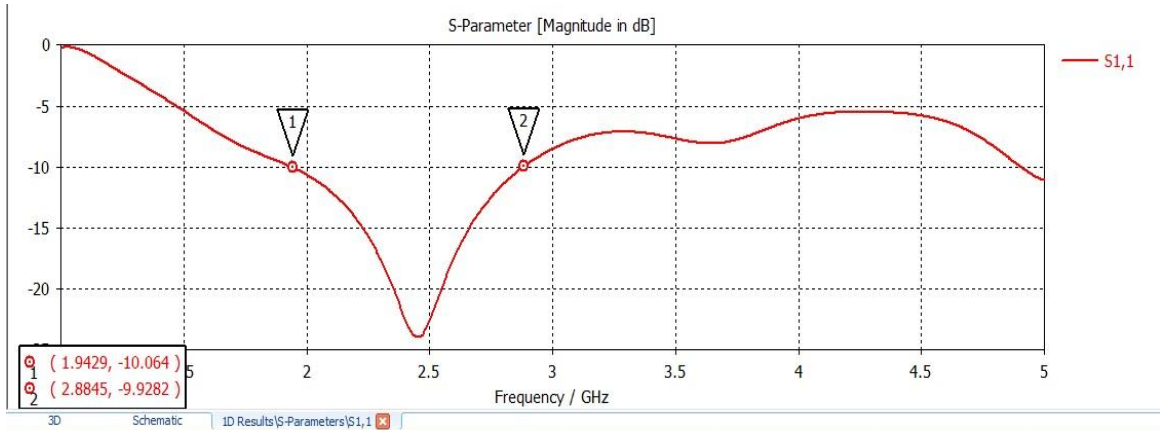

**Figure 4. 2 Simulated Design of CPW-fed CPSSA**

In Fig.4.3 the simulated results of S11(reflection coefficient) is shown. The antenna has an impedance bandwidth (  $S_{11} \leq -10\text{dB}$  ) of 941MHz (1.942 to 2.884 GHz) .

Antenna is resonating at 2.49 GHz frequency.



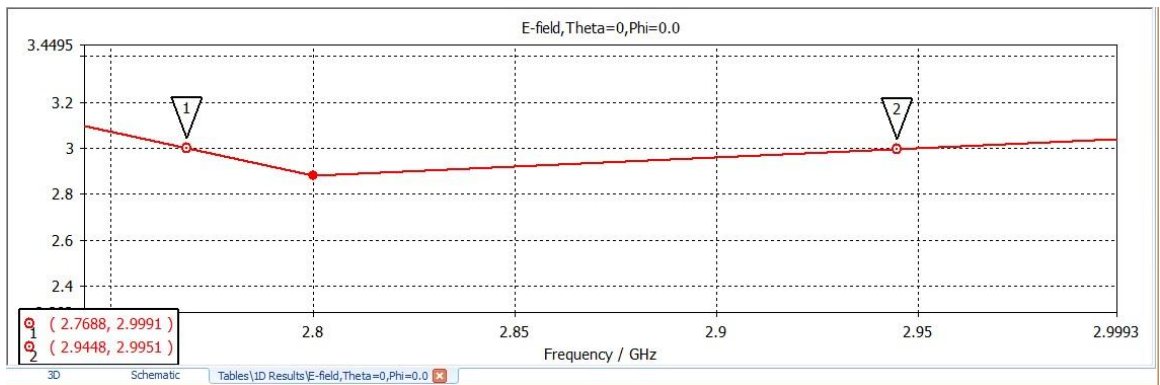

**Figure 4. 3 Simulated Reflection Coefficient of the antenna.**

Embedding Two inverted-L-shape grounded strips at the upper corner of square slots make the CP polarization possible. Because of these L strips current gets an path of rotation, that's why we are able to get circular polarization in this antenna structure.

The simulated Axial Ratio (AR) result is shown in Fig. 4.4. Axial ratio is defined as the ratio of the magnitude of major axis and minor axis in polarization ellipse. For the case of circular polarisation axial ratio must be unity(0 dB). As it is seen, the AR is in the frequency range of (2.7688-2.9448), the AR is lower than -3dB. In this bandwidth, it can be considered a circular polarization for proposed antenna.

Axial ratio is taken as the measure of circular polarisation.



**Figure 4. 4Axial Ratio of CPSSA**

The simulated result for the gain of the proposed antenna is shown in Fig.4.5.

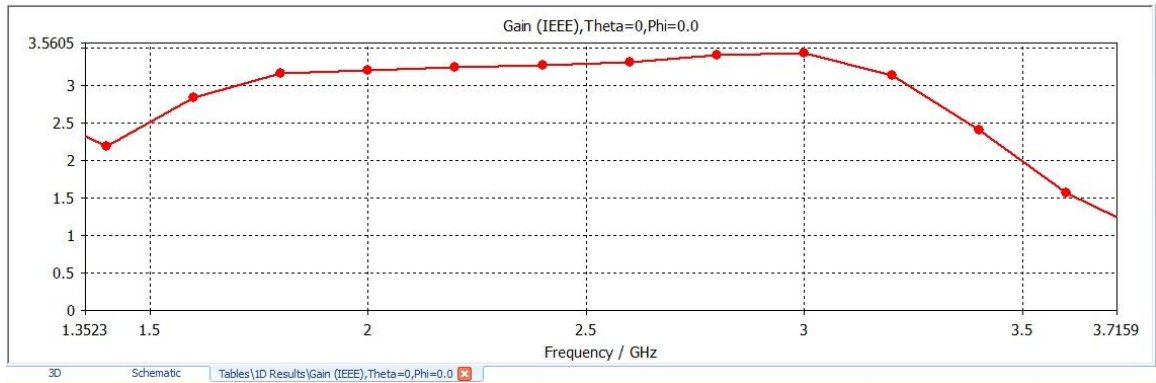

**Figure 4. 5 Maximum Gain Over Frequency**

The gain of proposed antenna is 3.5dB around the centre frequency 2.5 GHz.

The Bidirectional radiation pattern can be seen in Fig. 4.6.

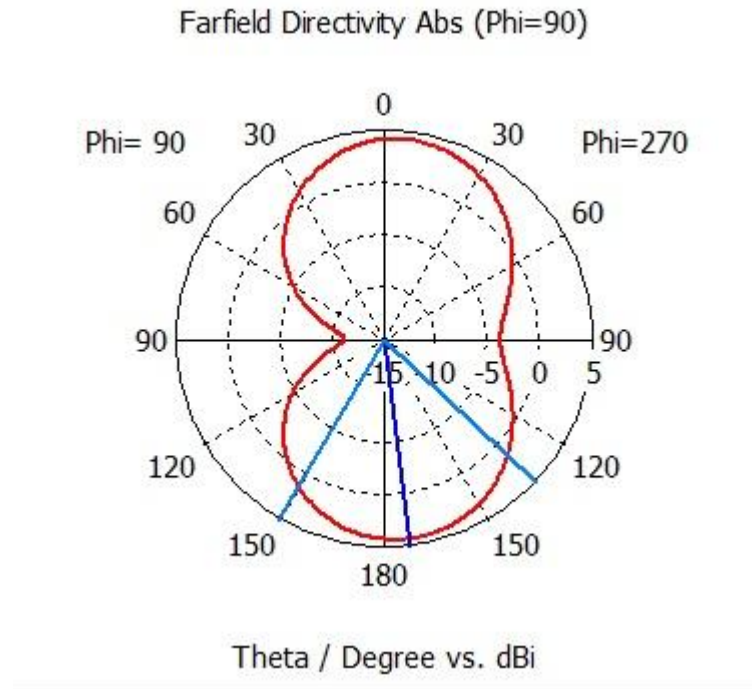

**Figure 4. 6 :- Radiation Pattern of CPSSA antenna**

The above result of radiation pattern shows that this antenna gives the bidirectional radiation means it radiates both directions.

#### 4.3.1 Simulation Results of antenna backed up with conventional AMC:-

Secondly, we have designed the same CPSSA backed up with conventional AMC/ $AMC_{ref1}$  (Artificial Magnetic Conductor) to simply increase the gain of the antenna as well as to convert the bidirectional radiation to unidirectional radiations.

The dimensions of the AMC reflector is as follows :- It is built on a square substrate of FR4 with a thickness  $h=3.5\text{mm}$ , a relative dielectric constant  $\epsilon_r=4.4$  and a loss tangent  $=0.02$ .

We can see the results as follows.

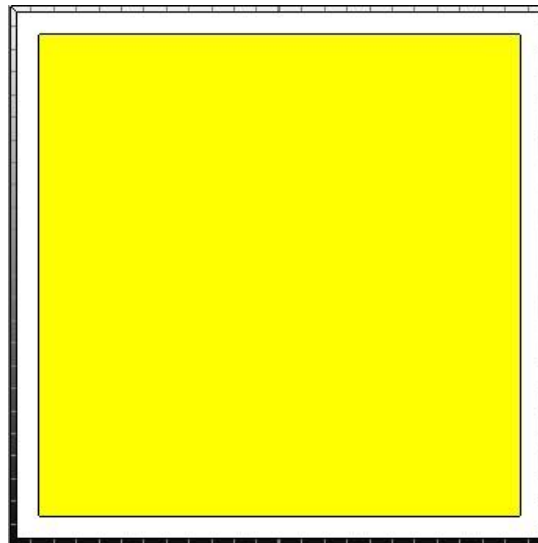

**Figure 4. 7 Unit cell of  $AMC_{ref1}$**

Above structure represents the unit cell structure of  $AMC_{ref1}$ . By repeating this unit cell in periodic manner we can create the AMC structure. The following figure represents the Reflection phase diagram of the AMC structure.

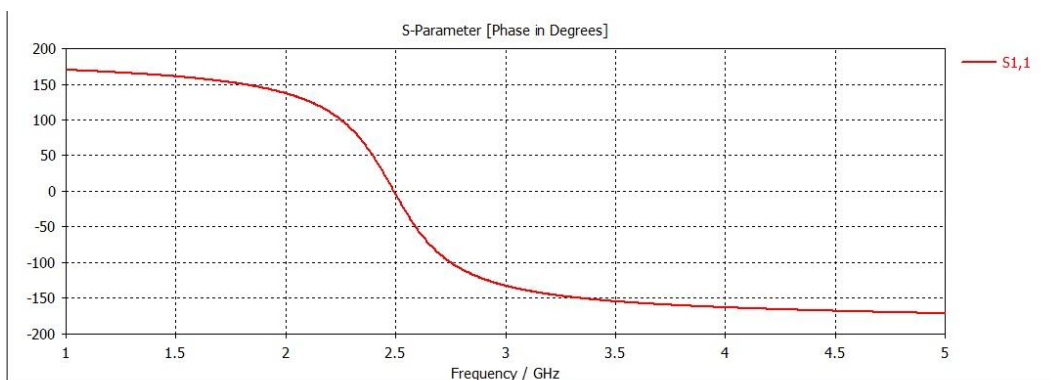

**Figure 4. 8 Reflection Phase Diagram of  $AMC_{ref1}$**

Reflection phase diagram signifies the ideal operating bandwidth for the use of the particular AMC structure. For example:- In above diagram AMC will provide 0 degree phase at 2.5 GHz frequency and its bandwidth will be between +90 deg to -90 deg. Meaning it will provide the in phase reflection around 2.5 GHz frequency. Meaning it will provide complete reflection in the range of 2.25GHz – 2.7GHz frequency. The following figure represents the Antenna backed up with the AMC structure.

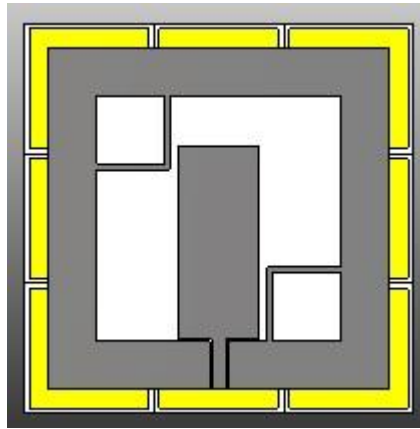

**Figure 4. 9 Square slot antenna backed up with AMC<sub>ref1</sub>**

The results of the Square Slot antenna backed up with AMC structure are as follows. Reflection Coefficient of antenna backed up with AMC of conventional square patch or AMC<sub>ref1</sub> is shown in fig.4.10.

Similarly maximum gain over frequency and the radiation pattern of antenna backed up with AMC<sub>ref1</sub> is shown in fig.4.11 and fig.4.12 respectively.

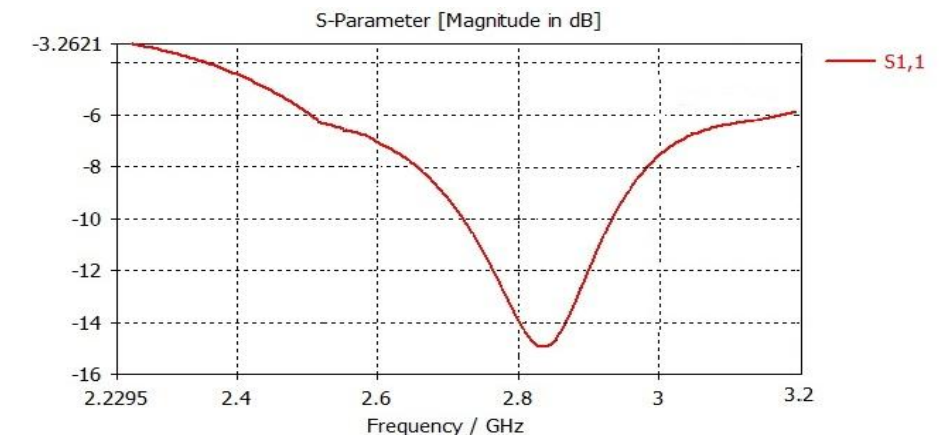

**Figure 4. 10 Reflection coefficient of antenna with AMC<sub>ref1</sub>**

As it is showing that CPSSA backed up with  $AMC_{ref1}$  resonating at around 2.7GHz frequency with a impedance bandwidth in the range of 2.6 GHz -2.8GHz frequency.

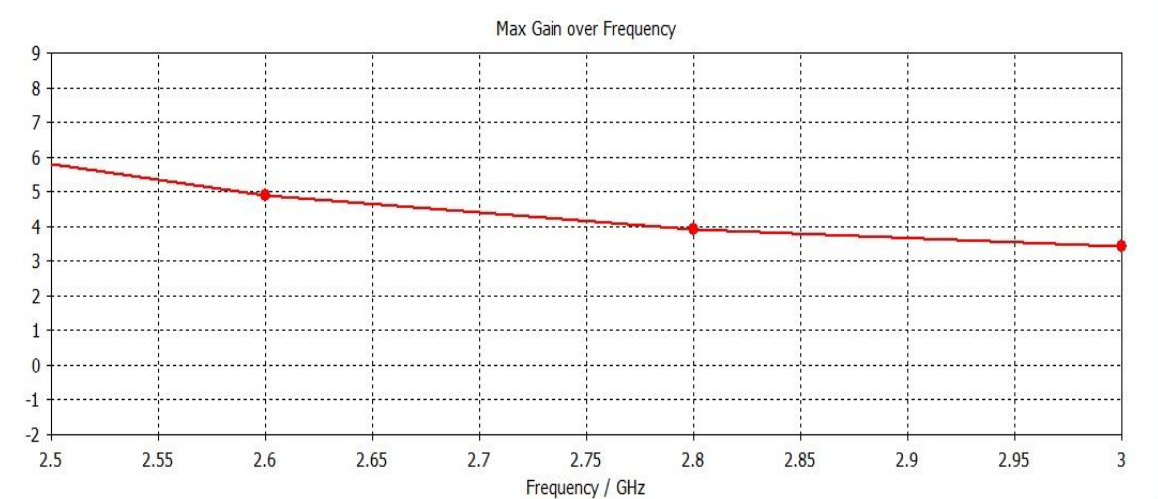

**Figure 4. 11 Maximum gain over frequency with  $AMC_{ref1}$**

As we can see the gain is around 2.7 GHz frequency is 4.5 dB. Which is 1 dB higher than the CPSSA without the “Artificial magnetic Conductor.” Meaning it is 28.57% higher than the previous one.

And the next result shows that antenna backed up with AMC gives the unidirectional radiation pattern rather than bidirectional radiation pattern.

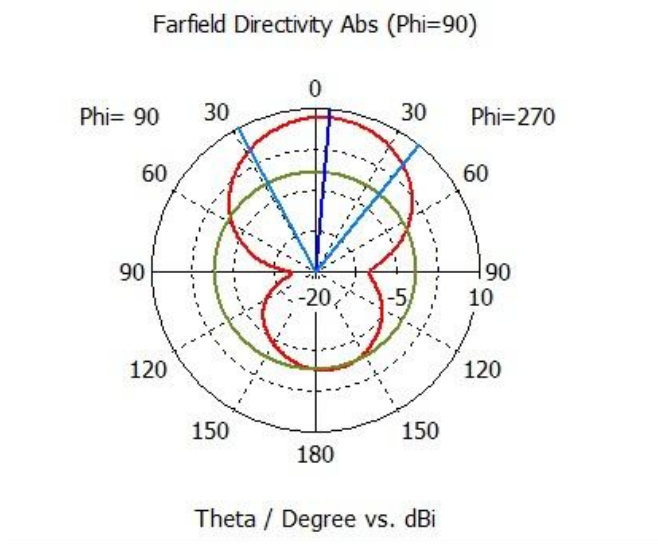
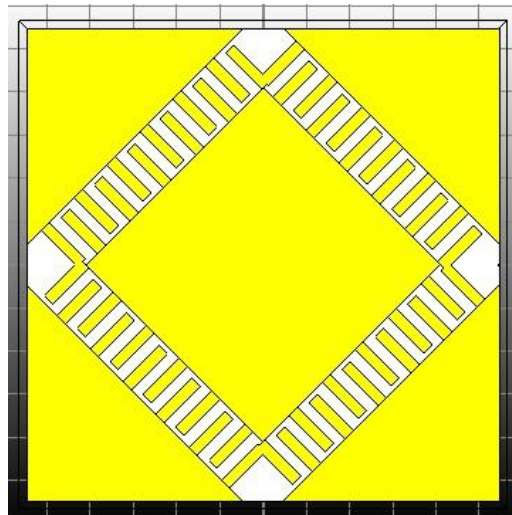

**Figure 4. 12 Radiation Pattern of Antenna with  $AMC_{ref1}$**

So from the above results it is clear that Antenna backed up with artificial magnetic conductor is giving higher gain over frequency and it is giving the unidirectional radiation pattern rather than the bidirectional radiation pattern.

#### **4.3.2 Simulation Results of antenna backed up with 12 fingers AMC:-**

Thirdly, we have designed the same CPSSA antenna backed up with 12 fingers AMC (Artificial Magnetic Conductor). In that AMC, the unit cell of AMC comprises an inclined patch at 45 degree with respect to z axis, and that introduces a inter-digital capacitor along both the x-axis and y- axis. The Inter-digital capacitor consists of 12, 1.18 mm long fingers and finger width is of 0.12 mm and the gap between the fingers is also 0.12 mm. Particularly, number of fingers, width between the fingers and gap between the fingers primarily determines the equivalent capacitance of the inter-digital capacitor and hence effect the frequency (centre frequency) of the AMC where an In-phase reflection appears. Reducing the gap between the fingers or increasing the width of the fingers produces a large equivalent capacitance, which lowers the center frequency and vice versa. We designed the similar antenna backed up with proposed AMC to simply increase the gain of the antenna as well as to convert the bidirectional radiation to unidirectional radiations. And we can also see that it does not effect the axial ratio or we can say the polarisation.



**Figure 4. 13 Unit cell of 12 fingers AMC**

Above structure represents the unit cell structure of 12 fingers AMC. By repeating this unit cell in periodic manner we can create the AMC structure. The following figure represents the Reflection phase diagram of the AMC structure.

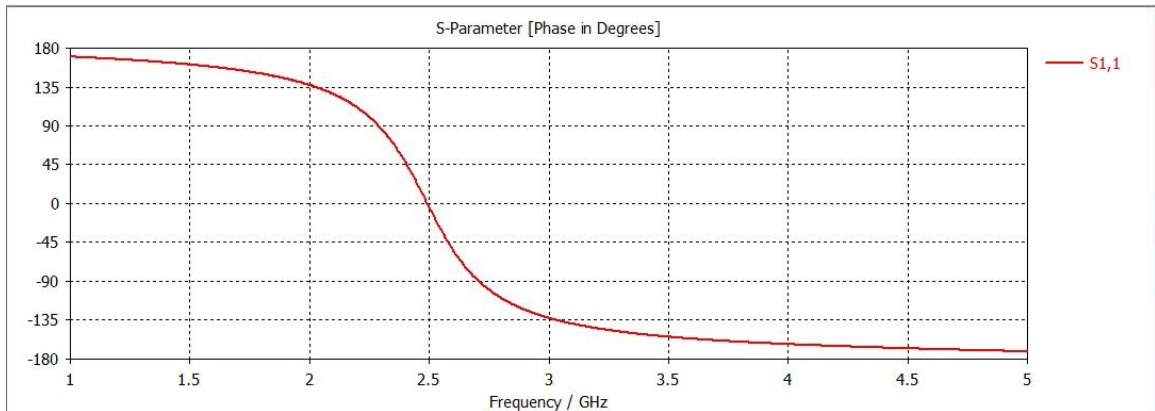

**Figure 4. 14 Reflection Phase Diagram of 12 fingers AMC**

Reflection phase diagram signifies the operating bandwidth for the use of the particular AMC structure. For example:- In above diagram AMC will provide 0 degree reflection phase at 2.5 GHz frequency and its bandwidth will be between +90 deg to -90 deg. Meaning it will provide complete reflection in the range of 2.3GHz – 2.8GHz frequency. The following figure represents the Antenna backed up with the AMC structure.

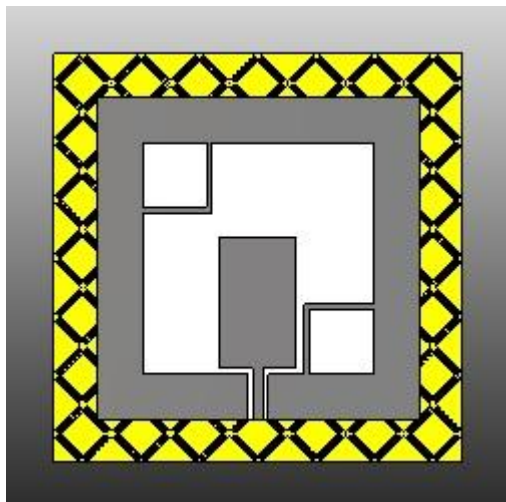

**Figure 4. 15 Square slot antenna backed up with 12 fingers AMC**

The other dimensions of the antenna remains same as shown in Table 3.1 except the tuning stub length  $L_t$ . This length is shortened or lengthened to account for the input impedance variation when different reflectors are applied. Here  $L_t=24.5\text{mm}$ . The results of the Square Slot antenna backed up with AMC structure are as follows.

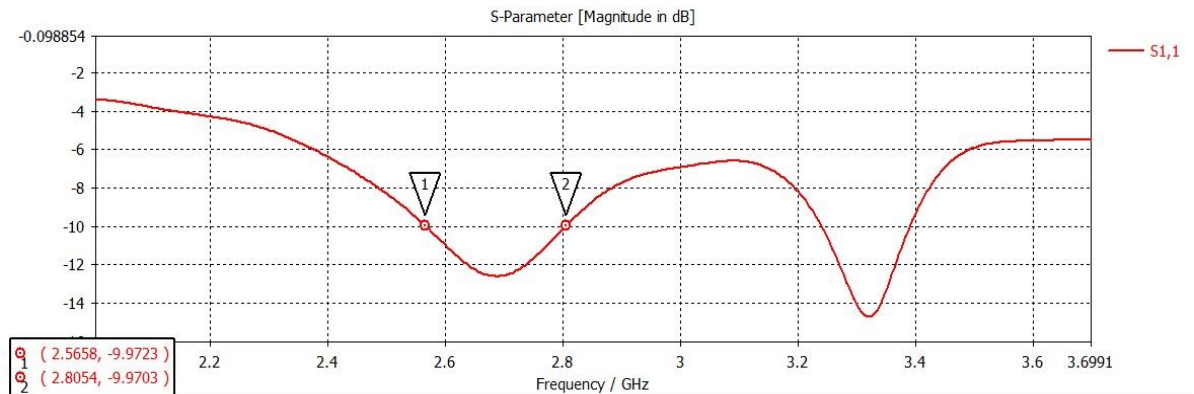

**Figure 4. 16 Reflection coefficient of antenna with 12 fingers AMC**

As it is showing that CPSSA backed up with 12 fingers AMC resonating at around 2.7GHz frequency with a impedance bandwidth in the range of 2.56 GHz -2.80GHz frequency.

The results of maximum gain over frequency is shown in next figure.

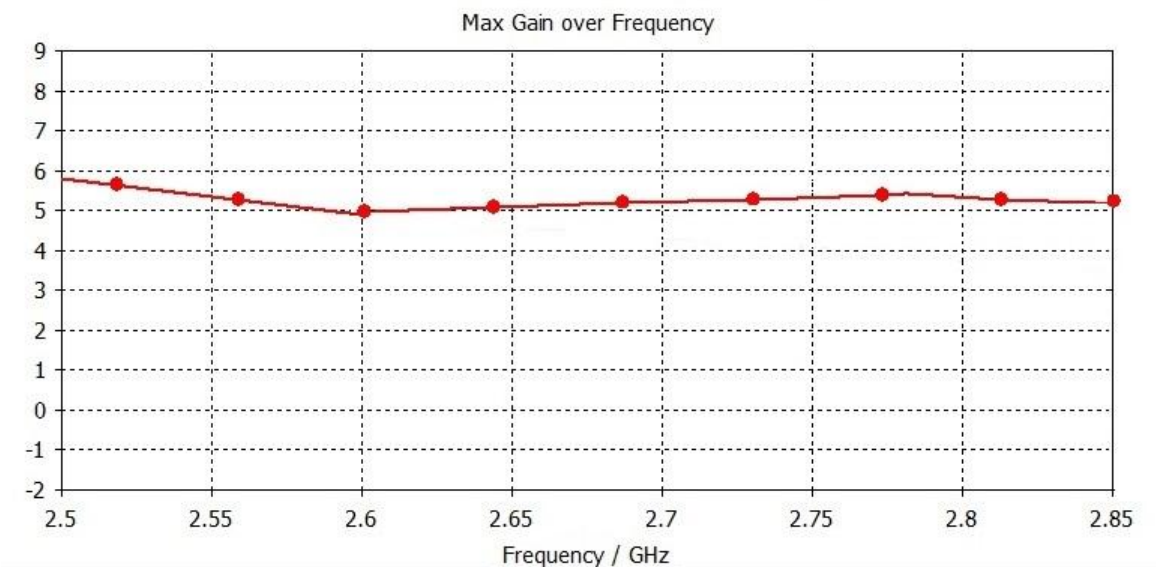

**Figure 4. 17 Maximum gain over frequency with 12 fingers AMC**



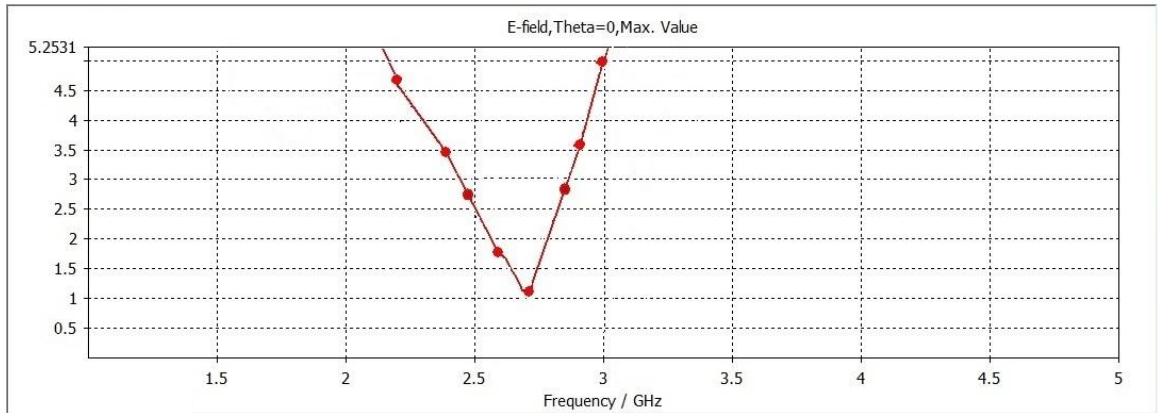

**Figure 4. 18 Axial ratio with 12 fingers AMC**

As we can see that the gain around 2.7 GHz or the constant gain over frequency range is 5.5 dB. Which is 2 dB higher than the CPSSA without the “Artificial magnetic Conductor” which is 57.14 % higher. And it is 1 dB higher than CPSSA backed up with  $AMC_{ref1}$  which is 22.22 % higher than the antenna backed up with  $AMC_{ref1}$ .

And the next result of antenna pattern also shows that antenna backed up with 12 fingers AMC gives the unidirectional radiation pattern rather than bidirectional radiation pattern.

It is following the unidirectional radiation property.

Which shows the basic property of the AMC which is 0 degree reflection phase provided around the centre frequency. Because of which the bidirectional radiation pattern of antenna converted into unidirectional pattern of antenna backed up with 12 fingers AMC (artificial magnetic conductor).

From figure 4.18 it is clear that antenna backed up with 12 fingers AMC is giving the circular polarization. The 3 dB CP bandwidth is in the range of 2.45 GHz to 2.81GHz.

The results of the unidirectional radiation pattern of the antenna backed up with the 12 fingers AMC is shown at the next page.

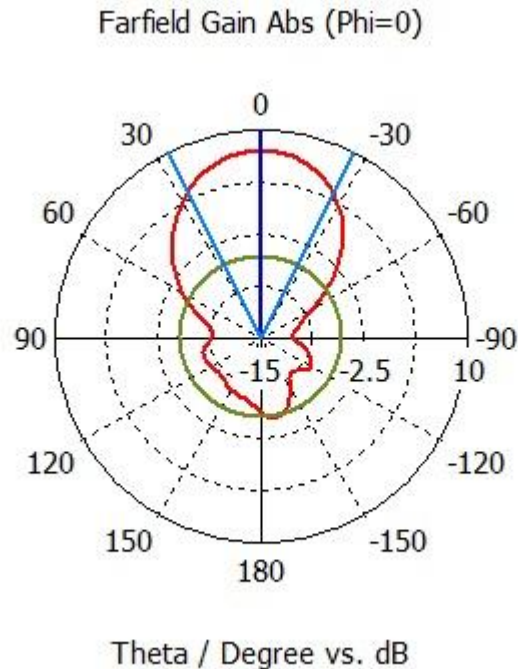

**Figure 4. 19 Radiation Pattern of Antenna backed up with 12 fingers AMC**

So from the above results it is again clear that Antenna backed up with Artificial magnetic conductor is giving higher gain over frequency and it is giving the unidirectional radiation pattern rather than the bidirectional radiation pattern.

Now as we can see from above result that the above antenna is resonating at 2.7 GHz frequency rather than 2.5 GHz. So if we able to change the reflection phase of  $0^\circ$  to around the centre frequency of 2.7 GHz than we can increase the gain of the antenna backed up with AMC more than the previous one.

As we know that by changing the finger width or gap between the fingers we can change the centre frequency but that change is not significant in terms of frequency. So by changing the number of finger we can get the significant change in the centre frequency of the reflection phase of the proposed AMC.

#### **4.3.3 Simulation Results of antenna backed up with 8 fingers AMC:-**

So Finally, we have designed the CPSSA antenna backed up with proposed AMC (Artificial Magnetic Conductor) with 8 fingers . In that AMC, the unit cell of AMC comprises a inclined patch at 45 degree with respect to z axis, and that introduces a inter-digital capacitor along both the x-axis and y- axis. The Inter-digital capacitor consists of 8, 1.18 mm long fingers and finger width is of 0.394 mm and the gap between the fingers

is also 0.394 mm. Particularly, number of fingers, width between the fingers and gap between the fingers primarily determines the equivalent capacitance of the inter-digital capacitor and hence effect the frequency (centre frequency) of the AMC where an In-phase reflection appears. Reducing the gap between the fingers or increasing the width of the fingers produces a large equivalent capacitance, which lowers the centre frequency and vice versa. We designed the similar antenna backed up with proposed AMC to simply increase the gain of the antenna as well as to convert the bidirectional radiation to unidirectional radiations. And we can also see that it does not effect the axial ratio or we can say the polarisation.

As we can see in following results.

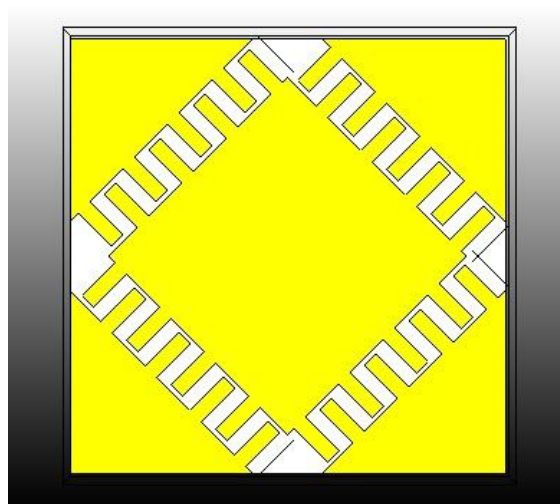

**Figure 4. 20 Unit cell of AMC with 8 fingers**

Above structure represents the unit cell structure of AMC. By repeating this unit cell in periodic manner we can create the AMC structure.

The following figure represents the Reflection phase diagram of the AMC structure. From the following figure we can see that the centre frequency of the 8 finger AMC structure is 2.68 GHz.

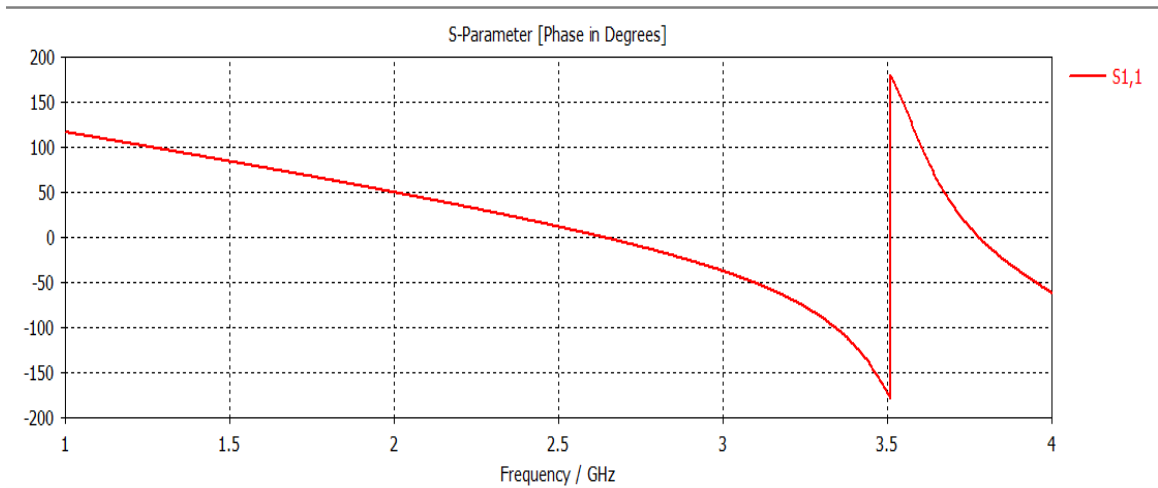

**Figure 4. 21 Reflection Phase Diagram of AMC with 8 fingers**

Reflection phase diagram signifies the ideal operating bandwidth for the use of the particular AMC structure. For example:- In above diagram AMC will provide 0 degree phase at 2.68 GHz frequency and its bandwidth will be between +90 deg to -90 deg. Meaning it will provide the in-phase reflection around 2.68 GHz frequency.

The following figure represents the Antenna backed up with the AMC structure.

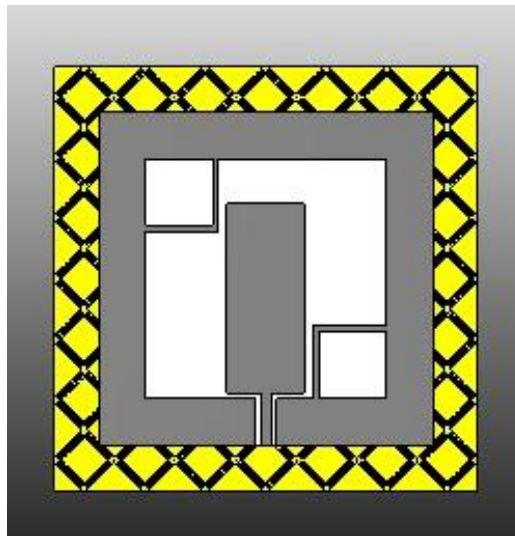

**Figure 4. 22 Square slot antenna backed up with 8 fingers AMC**

The results of the circularly polarized Square Slot antenna with tuning length  $L_t=33.9\text{mm}$  backed up with AMC structure are as follows.

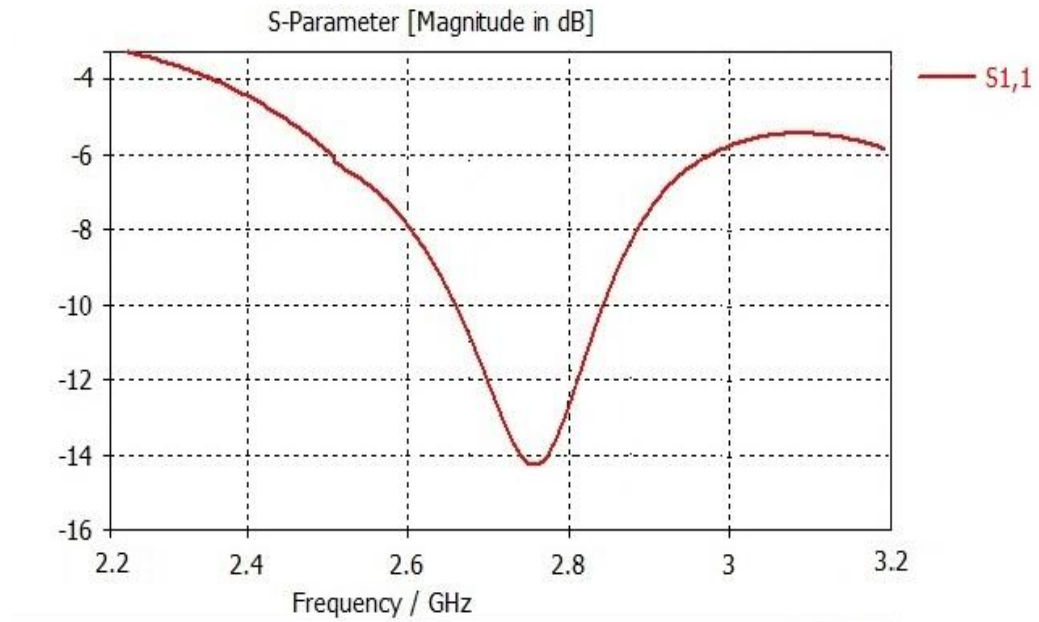

**Figure 4. 23 Reflection coefficient of antenna with 8 fingers AMC**

In Fig.4.23 the measurement and simulated results of S11 (reflection coefficient) is shown. The antenna has an impedance bandwidth ( $S_{11} \leq -10\text{dB}$ ) of 250MHz (2.63 to 2.884 GHz) .

The above figure also shows that the CPSSA backed up with AMC of 8 fingers is resonating at 2.7GHz frequency.

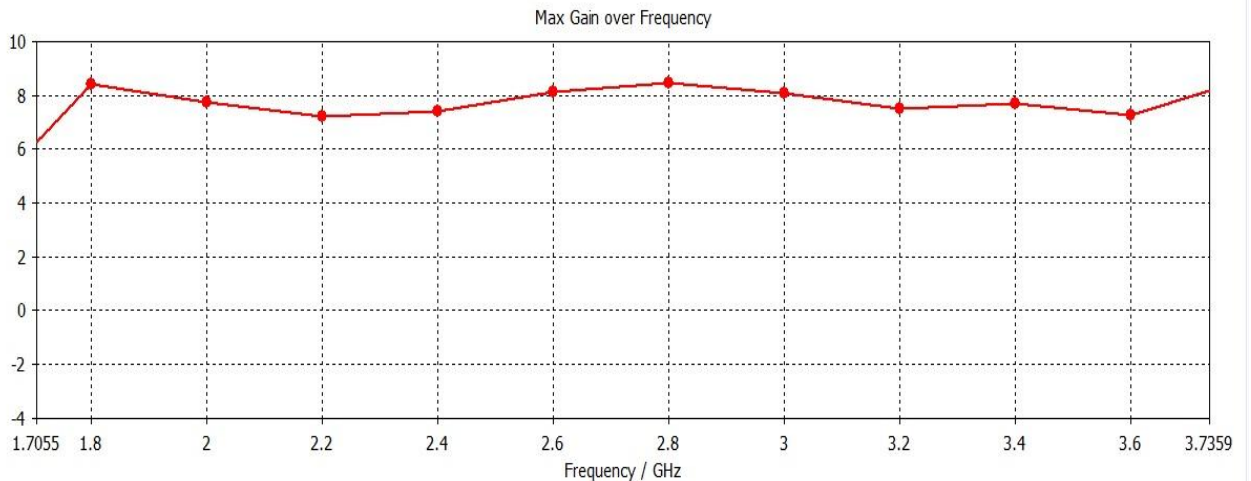
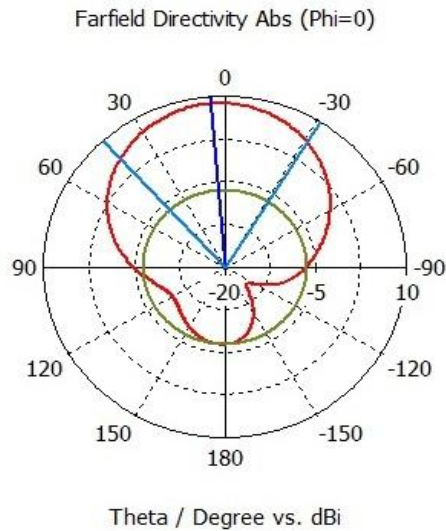

**Figure 4. 24 Maximum gain over frequency with proposed AMC with 8 fingers**

As we can see the gain around 2.7 GHz frequency is 8.5 dB. Which is 5 dB higher than the CPSSA without the “Artificial magnetic Conductor” as well as 4 dB higher than

CPSSA backed up with  $AMC_{ref1}$ . And 3 dB higher than the CPSSA backed up with 12 finger AMC structure.

And the next result of antenna pattern also shows that antenna backed up with  $AMC_{pro}$  gives the unidirectional radiation pattern rather than bidirectional radiation pattern.



**Figure 4. 25 Radiation Pattern of Antenna with 8 fingers AMC**

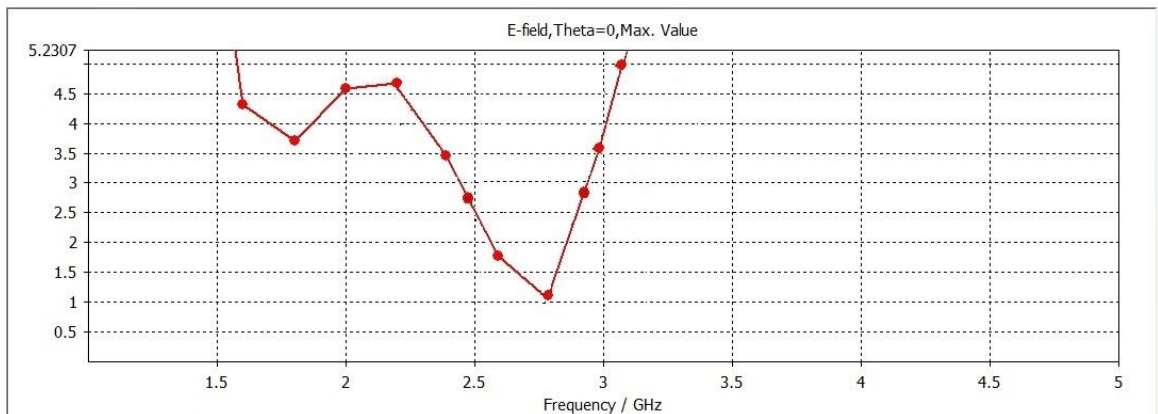

**Figure 4. 26 Axial Ratio with 8 finger AMC**

So from the above results it is again clear that Antenna backed up with Artificial magnetic conductor is giving higher gain over frequency and it is giving the unidirectional radiation pattern rather than the bidirectional radiation pattern. From figure 4.26 , the CP bandwidth is given by 2.42 GHz to 2.91 GHz.

And the gain is higher than the previous proposed AMC around 3 dB. Which is 54.54 % higher then the gain provided by antenna backed up with 12 fingers AMC And it also

shows that it is polarization independent as it is giving axial ratio below 3 dB shown in figure 4.25. And the gain is constant around 8.5 dB in complete CP bandwidth.

**Table 4. 2** Comparison table of antenna backed up with AMC's

	<b>Antenna backed up with 12 fingers AMC</b>	<b>Antenna backed up with 8 fingers AMC</b>
1. Gain	5.5 dB	8.5 dB
2. % Increase in gain	Which is 22.22% higher than the antenna with conventional AMC	Which is 54.54% higher than the antenna with 12 finger AMC
3. 10 dB impedance band width	2.56 GHz to 2.80GHz (240 MHz)	2.63GHz to 2.884 GHz (254 MHz)
4. CP bandwidth	2.45 GHz to 2.81GHz	2.42 GHz to 2.91 GHz

## CHAPTER-5

### Conclusion

---

So, on comparing the results of both antenna with 12 finger AMC and antenna backed up with 8 finger AMC structure, as shown in Table 3.2 it is clear that the Maximum gain (8.5 dB) over frequency of the antenna backed up with 8 fingers AMC is higher than the maximum gain (5.5 dB) of the antenna backed up with 12 fingers AMC. Which is 54.54% higher than the antenna with 12 fingers AMC. Antenna with 8 fingers AMC is also giving the unidirectional radiation pattern rather than the bidirectional radiation pattern and it is also polarisation independent.

This property of unidirectional radiation can be used in application like wireless local area network (WLAN), radio frequency identification (RFID) and global navigation satellite system (GNSS).

The future work is to increase the CP bandwidth of this antenna or to convert this antenna to multiband CP antenna. There is scope of further increasing the gain of the antenna and convert this antenna to wideband antenna.



## REFERENCES

---

- [1]. Jianxing Li, Huimin Huo, Juan Chen, Shitao Zhu, Hongyu Shi, Anxue Zhang, "Miniaturised artificial magnetic conductor and its application in unidirectional circularly polarised slot antenna design." IET Microwave Antenna Propagation 2018, Vol. 12 Iss. 12, pp. 1885-1889.
- [2]. Jia-Yi Sze, and Chi-Chaan Chang, "Circularly Polarized Square Slot Antenna With a Pair of Inverted-L Grounded Strips," IEEE Antennas and wireless propagation letters, vol. 7, 2008.
- [3]. Jong Gyun Baek and Keum Cheol Hwang, "Triple-Band Unidirectional Circularly Polarized Hexagonal Slot Antenna With Multiple L-Shaped Slits," IEEE transaction on Antennas and propagation, vol. 61, no. 9, september 2013.
- [4]. H. Liu, K.L. Ford and R.J. Langley, "Miniaturised artificial magnetic conductor design using lumped reactive components," ELECTRONICS LETTERS 12th March 2009 Vol. 45 No. 6.
- [5]. Jianxing Li, Huimin Huo, Hongyu Shi, and Anxue Zhang, "Unidirectional Circularly Polarized Slot Antenna Backed with Miniaturized AMC Reflector," IEEE International Symposium on Antenna and Propagation conference 2018.
- [6]. H. Liu, K.L. Ford, and R.J. Langley, "Miniaturized artificial magnetic conductor design using lumped reactive components," Electron. Lett., vol.45, no. 6, pp. 294-295, Mar. 2009.
- [7]. N. Haider, D. Caratelli, and A. G. Yarovoy, "Recent developments in reconfigurable and multiband antenna technology," Int. J. Antennas Propag., p. 14, 2013, 869170.
- [8]. Sweta Sarita Sarangi, and Ashish Kumar Sharma, "Rectangular Ring Reconfigurable Antenna for Wireless Communication." IEEE WiSPNET 2017 conference.
- [9]. Daisy Sharma, T. Shanmuganatham, "Design of Miniaturised FSS Microstrip Antenna for Ku Band Applications." IEEE International Conference on Circuits and Systems (ICCS 2017)

- [10]. Vahid Zarei, Mohammadnaghi Azarmanesh, Hamid Boudaghi, Sajjad Abazari Aghdam, "A Novel CPW- Fed Polarization Reconfigurable Microstrip Antenna," 83 ARFTG microwave measurement conference 2014.
- [11]. Jianxing Li, Huimin Huo, Juan Chen, Shitao Zhu, Hongyu Shi, Anxue Zhang, "Miniaturised artificial magnetic conductor and its application in unidirectional circularly polarised slot antenna design." IET Microwave Antenna Propagation 2018, Vol. 12 Iss. 12, pp. 1885-1889.
- [12]. J.X. Li, C.Q. Wang, A.X. Zhang, et al., "Microstrip-line-fed reactively loaded circularly polarized annular-ring slot antenna," J. Electromagn.Waves Appl.,vol. 31, no. 1, pp. 100-101, Jan.2017.
- [13]. J.K. Pakkathillam and M. Kanagasabai, "Circularly polarized broadband antenna deploying fractal slot geometry," IEEE Antennas Wireless Propag. Lett., vol. 14, pp.1286-1289, Feb. 2015.
- [14]. K. Agarwal, Nasimuddin, A. Alphones, "Unidirectional wideband circularly polarized aperture antenna backed with artificial magnetic conductorreflectors," IET Microw. Antenna propag. Vol. 7, no. 5, pp. 338-346, Jun.2013.
- [15]. S.X. Ta, I. Park, and R.W.Ziolkowski, "Circularly polarized cross dipole on an HIS for 2.4/5.2/5.8-GHz WLAN applications," IEEE Antenna Wireless Propag. Lett. vol. 12,pp.1464-1467, Nov. 2013.
- [16]. K.P.Ma, K. Hirose, F.R. Yang, Y. Qian, and T. Itoh, "Realization of magnetic conducting surface usingnovel photonic bandgap structure," Electro. Lett., vol. 34, pp. 2041-2042, nov. 1998.
- [17]. Vallecchi, A., Luis, J.R.D., Capolino, F., et al.: 'Low profile fully planar folded dipole antenna on a high impedance surface', IEEE Trans. Antennas Propag., 2012, 60, (1), pp. 51–62.
- [18]. Matthew N.O. Sadiku, Elements of electromagnetic, 3<sup>rd</sup> edition, Oxford university press 2005.
- [19]. Basics of antenna and antenna parameters, june 2017. [online]. Available: <https://www.tutorialspoint.com/files.pdf>.
- [20]. Hadarig, R.C., De Cos, M.E., Las-Heras, F.: 'Novel miniaturised artificial magnetic conductor', IEEE Antennas Wirel. Propag. Lett., 2013, pp. 174–177.

- [21]. Agarwal, K., Nasimuddin, , Alphones, A.: ‘Wideband circularly polarised AMC reflector backed aperture antenna’, *IEEE Trans. Antennas Propag.*, 2013, **61**, (3), pp. 1456–1461
- [22]. Ta, S.X., Park, I.: ‘Artificial magnetic conductor-based circularly polarised crossed-dipole antennas: 1. AMC structure with ground pins’, *Radio Sci.*, 2017, **52**, (5), pp. 630–641.