

A
DISSERTATION REPORT
ON
**A Wideband Aperture Efficient 60-GHz Series-Fed E-Shaped Patch Antenna Array
with Co polarized Parasitic Patches**

is submitted as a partial fulfilment of the degree of

MASTER OF TECHNOLOGY IN **ELECTRONICS AND COMMUNICATION
ENGINEERING**

BY

RAMINENI RAMGOPAL CHOWDARY

(2017PWC5225)

UNDER THE GUIDANCE OF

Prof. R.P. YADAV

&

DR. RAVI KUMAR MADDILA



**DEPARTMENT OF ELECTRONICS AND COMMUNICATION
ENGINEERING MALAVIYA NATIONAL INSTITUTE OF
TECHNOLOGY JAIPUR (JUNE 2019)**

Certificate

This is to certify that the dissertation report entitled **A Wideband Aperture Efficient 60-GHz Series-Fed E-Shaped Patch Antenna Array With Co polarized Parasitic Patches** submitted by **Ramineni Ramgopal Chowdary (2017PWC5225)**, in the partial fulfilment of the Degree Master of Technology in **Wireless and Optical Communication** of Malaviya National Institute of Technology, is the work completed by her under our supervision, and approved for submission during academic session 2018-2019.

Prof. R.P. Yadav
(Project Supervisor)

Dr. Ravi Kumar Maddila
(Project Coordinator)

Date:
Place:

Dept. Of ECE
MNIT Jaipur 302017

Declaration

I, Ramineni Ramgopal Chowdary, declare that this Dissertation titled as “**A Wideband Aperture Efficient 60-GHz Series-Fed E-Shaped Patch Antenna Array With Co polarized Parasitic Patches**” and the work presented in it is my own and that, to the best of my knowledge and belief.

I confirm that major portion of the report except the refereed works, contains no material previously published nor present a material which to be substantial extent has been accepted or the award of any other degree by university or other institute of higher learning. Wherever I used data (Theories, results) from other sources, credit has been made to that source by citing them (to the best of my knowledge). Due care has been taken in writing this thesis, errors and omissions are regretted.

Date:
Place:

Ramineni Ramgopal
ID: 2017PWC5225

Acknowledgment

*I take immense pleasure in thanking of gratitude to my guide **Prof. R.P. Yadav**, Professor, Malaviya National Institute of Technology (MNIT) Jaipur for being a source of inspiration and for timely guidance during the project. The supervision and support that he gave truly helped in the progression of my thesis. I am highly obliged to him for his valuable advices and moral support during research period.*

*I would like to express my gratitude and sincere thanks to our Head of Department (HoD), **Dr. D. Boolchandani**, Malaviya National Institute of Technology (MNIT) Jaipur for allowing me to undertake this thesis work and for his guidelines during the review process.*

I am also very thankful to my friends Rajat Arora, Richa Verma and Kamal Singh Khatak for their valuable suggestions and discussion, which I had with them about this research work. They also help me in designing work of my project.

I would also like to thank Ministry of HRD, Government of India for its support to me to pursue my Masters in Electronics and Communication Engineering from Malaviya National Institute of Technology, Jaipur. This support provided me library, laboratory and other related infrastructure.

Ramineni Ramgopal

List of Abbreviations

BW	-	Bandwidth
EM	-	Electromagnetic
WLAN	-	Wireless Local Area Network
WIFI	-	Wireless Fidelity
LTCC	-	Low Temperature Co-fired Ceramics
PCB	-	Printed Circuit Board
GAA	-	Grid Array Antennas
LP	-	Low Profile
MMIC	-	Monolithic Microwave Integrated Circuit
ISM	-	Industrial, Scientific and Medical
GCPW	-	Guided Co planar Waveguide
DD	-	Dense Dielectric
FEM	-	Finite Element Method
FDTD	-	Finite Difference Time Domain
Mom	-	Method of Moments
EMC	-	Electro Magnetic Compatibility
CAD	-	Computer Aided Design
SPIC	-	Simulation Program with Integrated Circuit
FT	-	Fourier Transform
PEC	-	Perfect Electric Conductor
VSWR	-	Voltage Standing Wave Ratio
HPBW	-	Half Power Beam Width

List of symbols

dB	-	Decibels
f	-	Frequency
c	-	Speed of light
GHz	-	Giga Hertz
mm	-	millimetre
λ	-	Wavelength
f_v	-	Maximum Frequency
f_l	-	Minimum Frequency
f_c	-	Centre Frequency
G	-	Antenna Gain
D	-	Directivity
η_e	-	Antenna Efficiency
A_e	-	Aperture Efficiency
A_p	-	Physical Aperture
A_{em}	-	Maximum Effective Aperture
G_o	-	Peak Gain of Antenna
ϵ_r	-	Permittivity

Abstract

An E-shaped patch antenna with increase in array structures up to four with and without co polarized parasitic patches is designed using HFSS 15.0 at 60-GHz unlicensed wide frequency band which spans from 57 GHz to 64 GHz. As the array size increases, the antenna bandwidth and peak gain increases. The impedance bandwidth increases up to three array and reduces thereafter. The gain flatness is best for one array. Aperture efficiency is also more for one array. The co polarized parasitic patches resonates at higher frequency than the E-shaped patch. By this there is an increase in the gain of the antenna over the same area. The gain flatness and aperture efficiency are also improved. On comparison of all parameters three array E shaped patch antenna is suitable at 60 GHz. This three array E shaped patch antenna is having dimensions as $6.0 \times 14.7 \times 0.25\text{mm}^3$. The three array E shaped patch antenna with and without parasitic patches is having 2.8 dB and 1.7 dB gain flatness over the 60 GHz band (57 – 66 GHz), 14.5 dBi and 13.8 dBi peak gain, and 64.9% and 53.7% aperture efficiency respectively, without any change in the dimensions of antenna.

TABLE OF CONTENTS

CHAPTER NO.	TITLE	PAGE NO.
	CERTIFICATE	ii
	DECLARATION	iii
	ACKNOWLEDMENT	iv
	LIST OF ABBREVIATIONS	v
	LIST OF SYMBOLS	vi
	ABSTRACT	vii
	LIST OF FIGURES	xi
	LIST OF TABLES	xvi
1.	INTRODUCTION	1
1.1	MOTIVATION	2
1.2	AIM	3
1.3	REPORT LAYOUT	3
2.	LITERATURE SURVEY	4
2.1	LITERATURE REVIEW	4
2.2	PROPOSED SYSTEM	9
3.	HFSS SOFTWARE	10
3.1	VARIOUS SOFTWARE TYPES	10
3.1.1	FEKO	10
3.1.2	IE3D	10

3.1.3 ANTENNA MAGUS	11
3.1.4 CST MWS	11
3.1.5 HFSS	11
4. ANTENNA DESIGN AND SIMULATIONS	13
4.1 ANTENNA PARAMETERS AND THE SIGNIFICANCE	13
4.2 MICROSTRIP PATCH ANTENNA	14
4.3 E SHAPED PATCH ANTENNA	20
4.3.1 E SHAPED PATCH ANTENNA WITH NO ARRAY	21
4.3.2 ONE ARRAY E SHAPED PATCH ANTENNA WITHOUT PARASITIC PATCHES	24
4.3.3 ONE ARRAY E SHAPED PATCH ANTENNA WITH PARASITIC PATCHES	28
4.3.4 TWO ARRAY E SHAPED PATCH ANTENNA WITHOUT PARASITIC PATCHES	31
4.3.5 TWO ARRAY E SHAPED PATCH ANTENNA WITH PARASITIC PATCHES	35
4.3.6 THREE ARRAY E SHAPED PATCH ANTENNA WITHOUT PARASITIC PATCHES	38
4.3.7 THREE ARRAY E SHAPED PATCH ANTENNA WITH PARASITIC PATCHES	41
4.3.8 FOUR ARRAY E SHAPED PATCH ANTENNA WITHOUT PARASITIC PATCHES	43

4.3.9 FOUR ARRAY E SHAPED PATCH ANTENNA	47
WITH PARASITIC PATCHES	
5. CONCLUSION	51
REFERENCES	52

List of Figures

Figure No.	Figure Name	Page No.
4.1	Microstrip patch antenna design in HFSS	16
4.2	Return loss of designed Microstrip patch antenna	16
4.3	Microstrip patch antenna gain in dB	17
4.4	E plane radiation pattern of Microstrip patch antenna at 60 GHz	17
4.5	H plane radiation pattern of Microstrip patch antenna at 60 GHz	18
4.6	Microstrip patch antenna gain	18
4.7	Aperture efficiency of Microstrip patch antenna	19
4.8	Equivalent circuit of Microstrip patch antenna	20
4.9	Equivalent circuit of centre part of E shaped patch antenna	20
4.10	Equivalent circuit of top and bottom parts of E shaped patch antenna	20
4.11	E shaped patch antenna showing dimensions	21
4.12	E shaped patch antenna with parasitic patches showing dimension	21
4.13	E shaped patch antenna with no array	22
4.14	Return loss of E shaped patch antenna with no array	22
4.15	E shaped patch antenna with no array gain in dB	22
4.16	E plane radiation pattern of E shaped patch antenna at 60 GHz	23
4.17	H plane radiation pattern of E shaped patch antenna at 60 GHz	23
4.18	Realized gain of E shaped patch antenna with no array	24

4.19	Aperture efficiency of E shaped patch antenna with no array	24
4.20	One array E shaped patch antenna without parasitic patches	25
4.21	Return loss of One array E shaped patch antenna without parasitic patches	25
4.22	One array E shaped patch antenna without parasitic patches gain in dB	26
4.23	E plane radiation pattern of One array E shaped patch antenna without parasitic patches at 60 GHz	26
4.24	H plane radiation pattern of One array E shaped patch antenna without parasitic patches at 60 GHz	27
4.25	Realized gain of One array E shaped patch antenna without parasitic patches	27
4.26	Aperture efficiency of One array E shaped patch antenna without parasitic patches	28
4.27	One array E shaped patch antenna with parasitic patches	28
4.28	Return loss of One array E shaped patch antenna with parasitic patches	28
4.29	One array E shaped patch antenna with parasitic patches gain in dB	29
4.30	E plane radiation pattern of One array E shaped patch antenna with parasitic patches at 60 GHz	29
4.31	H plane radiation pattern of One array E shaped patch antenna with parasitic patches at 60 GHz	30
4.32	Realized gain of One array E shaped patch antenna with parasitic patches	30
4.33	Aperture efficiency of One array E shaped patch antenna with parasitic patches	31

4.34	Two array E shaped patch antenna without parasitic patches	31
4.35	Return loss of Two array E shaped patch antenna without parasitic patches	32
4.36	Two array E shaped patch antenna without parasitic patches gain in dB	32
4.37	E plane radiation pattern of Two array E shaped patch antenna without parasitic patches at 60 GHz	33
4.38	H plane radiation pattern of Two array E shaped patch antenna without parasitic patches at 60 GHz	33
4.39	Realized gain of Two array E shaped patch antenna without parasitic patches	34
4.40	Aperture efficiency of Two array E shaped patch antenna without parasitic patches	34
4.41	Two array E shaped patch antenna with parasitic patches	35
4.42	Return loss of Two array E shaped patch antenna with parasitic patches	35
4.43	Two array E shaped patch antenna with parasitic patches gain in dB	35
4.44	E plane radiation pattern of Two array E shaped patch antenna with parasitic patches at 60 GHz	36
4.45	H plane radiation pattern of Two array E shaped patch antenna with parasitic patches at 60 GHz	36
4.46	Realized gain of Two array E shaped patch antenna with parasitic patches	37
4.47	Aperture efficiency of Two array E shaped patch antenna with parasitic patches	37
4.48	Three array E shaped patch antenna without parasitic patches	38

4.49	Return loss of Three array E shaped patch antenna without parasitic patches	38
4.50	Three array E shaped patch antenna without parasitic patches gain in dB	38
4.51	E plane radiation pattern of Three array E shaped patch antenna without parasitic patches at 60 GHz	39
4.52	H plane radiation pattern of Three array E shaped patch antenna without parasitic patches at 60 GHz	39
4.53	Realized gain of Three array E shaped patch antenna without parasitic patches	40
4.54	Aperture efficiency of Three array E shaped patch antenna without parasitic patches	40
4.55	Three array E shaped patch antenna with parasitic patches	41
4.56	Return loss of Three array E shaped patch antenna with parasitic patches	41
4.57	Three array E shaped patch antenna with parasitic patches gain in dB	41
4.58	E plane radiation pattern of Three array E shaped patch antenna with parasitic patches at 60 GHz	42
4.59	H plane radiation pattern of Three array E shaped patch antenna with parasitic patches at 60 GHz	42
4.60	Realized gain of Three array E shaped patch antenna with parasitic patches	43
4.61	Aperture efficiency of Three array E shaped patch antenna with parasitic patches	43
4.62	Four array E shaped patch antenna without parasitic patches	43
4.63	Return loss of Four array E shaped patch antenna without parasitic patches	44

4.64	Four array E shaped patch antenna without parasitic patches gain in dB	44
4.65	E plane radiation pattern of Four array E shaped patch antenna without parasitic patches at 60 GHz	45
4.66	H plane radiation pattern of Four array E shaped patch antenna without parasitic patches at 60 GHz	45
4.67	Realized gain of Four array E shaped patch antenna without parasitic patches	46
4.68	Aperture efficiency of Four array E shaped patch antenna without parasitic patches	46
4.69	Four array E shaped patch antenna with parasitic patches	47
4.70	Return loss of Four array E shaped patch antenna with parasitic patches	47
4.71	Four array E shaped patch antenna with parasitic patches gain in dB	47
4.72	E plane radiation pattern of Four array E shaped patch antenna with parasitic patches at 60 GHz	48
4.73	H plane radiation pattern of Four array E shaped patch antenna with parasitic patches at 60 GHz	48
4.74	Realized gain of Four array E shaped patch antenna with parasitic patches	49
4.75	Aperture efficiency of Four array E shaped patch antenna with parasitic patches	49

List of Tables

Table No.	Table Name	Page No.
3.1	Properties vs. software	12
4.1	Dimensions of microstrip patch antenna	15
4.2	Parameters of microstrip patch antenna	19
4.3	Dimensions of E shaped patch antenna	21
4.4	Properties of different E shaped patch antenna arrays	50

CHAPTER 1

INTRODUCTION

In WLAN, Wi-Fi and other communication devices that use 2 GHz and 5 GHz bands [12] data rate is low. In the present world, high data rate [3] is required for fast transfer of data. Most of the wireless devices that require high-data rates are used in millimeter-wave frequency-band systems, such as Wireless HD, fifth-generation (5G) technology and Wireless Gigabit (WiGig). To attain high data rates 60 GHz band is used. This 60 GHz band [10] is an unlicensed band [8] which is allocated in several regions and is having a bandwidth of 7 GHz ranging from 57–66 GHz. It comes under millimeter wave frequency band. It is used for high data-rates [9] and for high definition streaming. Based on this it is used in many practical applications, such as wireless gaming, fast bulk file transfer and mobile distributed computing, are viable. For this frequency band, a high gain antenna array is to be developed that can reduce the severe path loss during propagation. Many designs are proposed for this issue consisting of multi-layers including LTCC [10]. But, these designs are having some drawbacks that incur compact packaging, high manufacturing costs and involve complex antenna structure. For example, a slot antenna [10], vertical off-center dipole antenna array [6] and a grid antenna array [4] are proposed. But these designs are having drawbacks such as high manufacturing costs and require a complex antenna structure. To reduce the cost, a low-profile PCB [2] antenna is chosen.

For constant connectivity with counterpart systems irrespective of their position, 60 GHz radios must have broadside radiation antennas and end fire radiation antennas. Broadside antennas, such as slot and patch antennas are having a large ground plane comparable to the radiator size that isolates radiator from adjacent electrical components. But the end fire antennas, such as Vivaldi antennas, dipole antennas or Yagi antennas are not completely isolated from the adjacent electrical component that causes distortion in the radiation pattern, and also affects the electrical components as signal leakage or noise. To isolate from the adjacent electrical components horn antenna is used. The horn antenna is encircled with metal, so there will be no interference with adjacent electromagnetic

components. So the horn antenna guarantees isolation from adjacent electromagnetic components. But these horn antennas are not adopted for beam-switching functions. Thus, an antenna with self-isolation and beam-switching functions is to be designed. Based on the above things micro strip patch antenna will be suitable for 60 GHz antennas.

1.1 MOTIVATION

Because of oxygen and walls, this band shows an attenuation rate over distances. So in the same area frequency reuse is possible without any interference. Most of 60 GHz antennas have poor gain flatness in this unlicensed band. In addition to the compact packaging and manufacturing cost, less attenuation and gain flatness and self isolation must be taken into consideration. For a single layer design, a microstrip patch antenna is good choice rather than the slot antenna. Even the microstrip antennas are low cost, easy to fabricate, small size and low profile they have low gain, which leads to no development in wireless systems. To overcome this parasitic patches are stacked on the main radiation patch. But the height of microstrip antennas is increased by this stacked structure. Another efficient method to enhance the gain of microstrip antennas is coupling fed. But the low-profile patch type antenna has a narrow bandwidth. For this problem U slot patch [30], aperture coupled feeding [26] and L probe feed methods [7] can be used. But these methods are having multi-layer structure.

Fan Yang [1] introduced a single layer structured E-shaped patch antenna which gives a wide impedance bandwidth [1] and unidirectional 3-dB gain bandwidth. If the rectangular antenna patch is cut into two parallel slots [5], E shaped patch antenna is formed. To get more aperture-efficiency and flat gain, an array structure with co-polarized parasitic patches [13] is designed in which the current flows with the same polarity as in E-shaped patches. By improving the structure of the antenna elements, gain can be limited and by setting array antenna gain is increased.

1.2 AIM

The projects objective is

- (a) To design E shaped patch antenna with and without parasitic patches
- (b) To improve the aperture efficiency and peak gain

1.3 REPORT LAYOUT

The introduction and the objective of the project are described in Chapter 1. Chapter 2 deals with the literature survey. The software used for antenna design is discussed in chapter 3. The design of proposed antenna and simulations results are explained in Chapter 4. Chapter 5 is about the conclusion.

CHAPTER 2

LITERATURE SURVEY

2.1 LITERATURE REVIEW

This section includes studies in the increment of gain in 60 GHz band using different types of antennas. Various sizes and shapes of antennas are used to increase the gain. At the starting multi layered antennas are used and as the time progresses single layered antennas came into existence. From 2001 to till now how the work has done is described below

F. Yang, et al. [2001] [1]: In this E shaped patch antenna is designed from microstrip antenna that is divided into two parallel slots. Based on the current flow on the patch and also the position of slots, wideband mechanism is investigated. To have a wider bandwidth the antenna parameters like slot width, position and length are to be optimized. The simplicity and small size of this antenna is preferred over wide band conventional microstrip antennas. There is one resonant frequency for small slot length. There is another resonant frequency with increase in slot length. The effect shown by the two slots to extend the bandwidth are different at resonant frequencies. The current amplitudes in the slot are nearly same to that of patches right and left edges. Patch width determines the high frequency. The current amplitudes at higher frequencies are lower than at low frequencies. The inductance effect in the slots makes it resonate at low frequencies. The higher frequencies are determined by antenna width. The antenna width and slot length makes dual resonant frequencies for greater bandwidth.

B. Zhang, et al. [2012] [2]: In this GAA [4] with multi feed sub grid arrays is designed. There is flexibility in its design and the radiation characteristics are efficient. GAA may be linearly polarized or circularly polarized and balanced or unbalanced. For an unbalanced linearly polarize GAA, Ferro A6M LTCC [8] technology is used to resonate at 61.5 GHz. This GAA is of four sub grid arrays and four feed points linked by a T junction network which is quarter wave matched, to a 50- Ω source which is single ended.

In slot array and patch array antennas, impedance bandwidth is narrow. So Kraus proposed GAA in 1964 and from 2008 more work is done on GAA in 60 GHz band. Due to increase in LTCC vertical shrinkage from 63 GHz to 66 GHz, the lower frequencies of the LP GAA transfers to higher frequencies. The dielectric constant of LTCC substrate [7] varies and this varying dielectric constant and vertical shrinkage change the permittivity. The change in permittivity changes the resonant frequency due to inaccuracy of loop dimensions. The overall frequency response of GAA is determined by the resonant behavior of multi loop configuration. The main beam of GAA is in the broadside direction. The E and H patterns are having some cross polarization components. The change in vertical shrinkage and permittivity does not affect the GAA radiation pattern.

Y. Wang, et al. [2012] [3]: In this E shaped series fed patch antenna is designed. Two E shaped patches are connected in series to improve gain. They may also be connected in parallel but the series array antennas are easy to fabricate and an extra feed is required but there is shift in frequency of the beam direction offset at E plane. The elements are adjusted to increase radiation efficiency. There is loss of energy while travelling from one element to other element, so radiation efficiency is less in series fed antennas. When the phase of elements in series is same then radiation efficiency increases. The transmission line length connecting the series elements controls the phase of these elements. The elements in series are in phase if resonant frequency is same as the given frequency. The next element has more phase if resonant frequency is less. The next element has less phase if resonant frequency is high.

C. W. Byeon, et al. [2013] [4]: In this fully integrated transceiver using on-off keying (OOK) modulation for a dense and low-power design is tuned to 60 GHz. The transceiver is made on a single chip so that it is easy to fabricate. Due to high speed modulator or demodulator, highly efficient transmitter and wideband characteristics, the transceiver is having low-power and high data rate. The transmitter and the receiver is implemented using 90-nm CMOS technology and consume 31 and 36mW respectively at 10.7 Gb/s and also occupy an active footprint of 0.15 and 0.29 mm, respectively. The transceiver

along with the Yagi Uda antenna is fixed on board. The data is transmitted using on–off keying (OOK) modulation over 10 cm. The bit-error rate is less than 10^{-12} for $2^7 - 1$ binary pseudorandom sequence. The implemented transceiver gives an energy efficiency of 6.26 pJ/bit. The antenna gain obtained is 6.83 dBi which is less when compared to PCB made antennas. Based on the obtained results the implemented transceiver can be used for short range wireless communications such as between chips, boards, and devices.

Z. Briqech, et al. [2013] [5]: A printed multilayered Yagi antenna with dimensions $1.0687 \times 0.8015 \text{ cm}^2$ is designed with low-cost, more efficient and high radiation efficiency. The proposed antenna contains two planar stacked layers. On the second layer the printed Yagi parasitic array elements are placed and the first layer is electromagnetically coupled to the second layer for the transfer of energy. The surrounding parasitic patches on the first layer get current from the driven elements. The electrical field from the surrounding parasitic patches on first layer passes to the parasitic patches on second layer. This antenna operates over the ISM band. The designed antenna has a gain of 10 dB and bandwidth of 5 GHz at 60 GHz. By these values this antenna acts as a low profile antenna which is suitable for short range communication, MMIC packaging and imaging applications.

L. Wang, et al. [2013] [6]: A multilayered 4×4 L-probe patch antenna array using LTCC technology [6] is designed. This antenna array is having novel soft surface results in a high gain in the impedance bandwidth. This surface structure consists of metal strips. The losses due to surface waves are reduced by fences. For the improvement of radiation performance, mutual coupling is there between adjacent elements. The dimensions of the proposed antenna array are $14.4 \times 14.4 \times 1 \text{ mm}^3$. There is a little difference between the simulated results and the results obtained by measuring the fabricated antenna. This is due to fabrication tolerance. The stronger surface structure is having high dielectric constant and the substrate is thick. Due to this there will be less broadside radiation. But in the soft surface, the surface wave is greatly suppressed. This is having better results when compared to the above design is due to its dimensions are small.

H. Chu, et al. [2013] [7]: In this a wideband vertical off center dipole antenna array is designed using LTCC [11] at 60 GHz. The four channels of the dipole antenna are covered by off center fed technology. To get the maximum gain the 4×4 planar array is to be optimized. To increase the beam width the beam steering array is to be optimized. For the measurement of antenna after fabrication, GCPW technology is used. Due to dielectric loss and metal chunk there is a slight difference between measured and simulated results. All the 16 elements present in the antenna are fed by strip line network with same amplitude and phase. The current distribution at resonance on two radiating arms has equal intensity and orientation. So at first resonance the antenna resonates as quasi dipole. At second resonance current flows around the antenna aperture leaving two arms indicating that it is standing wave. The slot in the ground plan is having more current than current on the two arms. So at first resonance the current passes through the arm which is connected to the ground plane indicating it is a travelling wave

K. S. Chin, et al. [2014] [8]: This paper presents a 60-GHz wideband antenna which is multilayered with a slot-patch structure with dual-resonance fabricated at low temperature using co-fired ceramic as substrate. The resonant half-wavelength slot is designed using a backed SIW cavity to increase the front radiation. For impedance matching and signal excitation, an inverted microstrip with center-fed structure is designed. To improve bandwidth and gain, parasitic patch is introduced. The various parameters of the antenna are studied with and without parasitic patches. The addition of parasitic patches shows an increase in gain by 1.85 dB. They also increase the resonance of poles and bandwidth by 9%. To further improve gain and bandwidth, a 2×2 slot-patch antenna array which is dual resonant is introduced. When compared to a 8×8 SIW fed cavity array, 4×4 patch array with open air cavity, 4×4 patch array with embedded cavity, 2×2 multilayer parasitic patch array and a 2×2 aperture coupled patch array, the designed antenna is having less antenna gain and a high bandwidth. If all antennas are taken into consideration the designed antenna is having more bandwidth and 8×8 SIW fed cavity array is having high gain. Based on the specific application, the type of antenna is used.

Y. Li, et al. [2014] [9]: In this a 4×4 DD patch antenna array with aperture coupled is designed by using PCB technology at 60 GHz. There will be a broadside radiation which is symmetrical with cross polarization. A microstrip patch antenna in which metallic patch is replaced by high permittivity dielectric substrate which is thin. There is a reflection of electromagnetic waves between DD patch and the substrate due to which cavity mode is excited between the ground plane and DD patches lower surface. At lower microwave frequencies, the DD patch shows back lobe, low cross polarization and radiation pattern which is unidirectional and symmetrical. Impedance bandwidth can be increased by the introduction of feeding aperture resonance. In the impedance bandwidth the main lobe is pointed towards the broadside. The coupling aperture resonance is close to higher frequencies due to which radiation in back lobe increases. So at lower frequencies back lobe is small while at higher frequencies it is large. To measure backside radiation the equipment is not there.

T. Jang, et al. [2015] [10]: In this E shaped wideband patch antenna is designed at 60 GHz. The resonant frequencies of the antenna designed in and in this antenna are 1.9 GHz and 60 GHz. The LC resonant circuit can be drawn for a microstrip patch antenna. The bottom and top parts of patch antenna gets current from the feeding point. But in the patch, containing slots, current flows like normal patch at the center and in the slots it flows around them changing current path length. The additional inductance is added to the previous inductance. So the slots will resonate at low frequencies. The bandwidth gets wider due to this.

2.2 PROPOSED SYSTEM

An E shaped patch array antenna having parasitic patches which are co polarized to increase aperture efficiency at 60 GHz is designed. There are four elements in the array antenna [22] and the parasitic patches are placed between the array elements. These parasitic patches present between the series array elements give extra radiation and resonant offset frequency. They improve the aperture efficiency and antenna gain. The current from the parasitic patches [14] flows with the same polarity from one array element to the other resulting in increase of antenna gain without change in antenna

dimensions. The polarities are present at the corners of each antenna while current flows through it. When this current passes through parasitic patches the positive charges go to the point which is nearer to feeding and vice versa. The current reverses its direction in parasitic patches through series fed with same polarity. The E shaped patch length is greater than parasitic patch length and the resonant frequency of E shaped patch is less than parasitic patch. The gain at parasitic patch resonant frequency is more than E shaped patch resonant frequency. The parasitic patches counteract the gain at higher frequencies so that the flat gain will come. The parasitic patches resonate at 67 GHz. The addition of parasitic patches increases gain with same antenna area so that there is increase in aperture efficiency.

CHAPTER 3

HFSS SOFTWARE

In this antenna is designed using latest version of HFSS software. The width and length of middle patch and the parallel slots are found out by the formulas. There is brief description about the various software types and how HFSS is advantageous over the other software. In antenna design what kind of material is used is discussed.

3.1 VARIOUS SOFTWARE TYPES

There are different software for design of antenna. Each software is useful for specific type of application. The properties to be considered while designing an antenna are antenna dimensions, modeling and material properties. For antenna modeling there are different methods such as FEM, FDTD, MoM [31], etc. different software used different methods for antenna simulations. The various software used are described below

3.1.1 FEKO

FEKO, a software by Altair technologies designed for computational electromagnetics. FEKO means “Feldberechnung fur Korper mit beliebiger Oberflach,” a German word meaning calculation of fields that involve different shapes. It can be used for filters and time or frequency calculation tools. It used MoM method based on Maxwell’s equations. FDTD method is added in the latest version. FEKO deals with various antennas like horn antennas, patch antennas, problems in EMCs and radiation pattern. FEKO has import and export characteristics by which external files from other platforms can be used.

3.1.2 IE3D

IE3D is Zeland software presently known as Mentor Graphics. For high frequency circuits and for signal integration, IE3D is the first platform for design and verification. IE3D is multi threaded architecture with distributed simulation. At circuit level and component level of modeling and EM simulation IE3D costs less. IE3D can perform more simulations at a given time. For repetition of tasks automations is useful to reduce

errors. This automation is there in IE3D. IE3D follows MoM method and meshing for simulations in frequency domain IE3Ds interface is not good for close details on geometry.

3.1.3 ANTENNA MAGUS

To accelerate antenna modeling and design, Antenna Magus Software is used. It has database of 300 or more antennas. By this antenna design will be fast. Different antenna elements can be selected from the database without designing the antenna from the starting. For the study of EM interface antenna magus is easy. After antenna elements are selected, it validates the design. Using the existing antenna designs, it creates new antenna prototypes. The imported files of any format are accepted and files can be exported to other software applications for further study.

3.1.4 CST MWS

CST MWS means Computer Simulation Technology Micro Wave Studio. It is used for high frequency elements simulation using 3D EM. For analysis of couplers, antennas, multi layer structures and filters. For high frequency elements it gives quick insight. In CST both frequency and time domain solves are present. It can take SPICE software parameters and some CAD files. It has a good interface for geometry. CST works on similar method to FDTD. It uses FT to transform results form time domain to frequency domain in one run.

3.1.5 HFSS

HFSS means High Frequency Structure Simulator. HFSS is from Ansys and uses FEM for electromagnetic elements. For packaging, transmission lines, filters and radio frequency components, HFSS can be used. In HFSS, FEM is for frequency domain, FET us for time domain, Integral Solver for scattering and radiation problems and Creeping wave Physics for antenna mounted on curved surfaces. For conversion of time domain results into frequency domain results many operate are there in HFSS but it uses FT. A linear circuit design is possible. It automatically integrates the design.

Table 3.1: Properties vs. software

Properties\ Software	FEKO	IE3D	Antenna Magus	CST	HFSS
Method used	MoM	MoM	Suits for design only	FDTD	FEM
Antennas that can be designed	Patch antennas, horn antennas, reflector antennas	Patch antennas, horn antennas	Database of 300 antennas are present	Maximum antennas can be designed	Maximum antennas can be designed
Interface	Worst	Not so good	good	best	Best
Wideband results	No	No	Suitable for design only	Uses FT	Uses FT
Files import and export	NO	NO	YES	YES	YES
Automatic integration	NO	NO	YES	YES	YES
Accurate results	BEST	BEST	Suitable for design only	BETTER	GOOD

From the above table HFSS is suitable for the antenna design compared to others. So the antenna is designed using HFSS. Antenna design is difficult in CST and antenna simulation is difficult in HFSS. Simulation results are closer to measured results in HFSS. Discrete frequency is present in HFSS.

CHAPTER 4

ANTENNA DESIGN AND SIMULATIONS

How microstrip patch antenna is suitable at 60 GHz is discussed in Chapter 1. A microstrip patch antenna is to be designed at 60 GHz. A patch antenna consists of ground, substrate and a metallic patch. Selection of a substrate material is important for antenna functioning. It gives mechanical support to the antenna. For this, substrate must be of dielectric so that antenna, circuits and transmission lines performance may affect. Substrate must be chosen based on size, cost and efficiency. Fabrication of patch antenna is done by etching the antenna pattern on a metal trace which is attached to an insulating substrate having metal layer bonded continuously to the other side of substrate which is ground plane. Substrate helps in producing time varying Magnetic Field from displacement current by Ampere's Law. Time varying electric field is produced by time varying Magnetic Field by Faraday's Law and creates an EM Field. So the selection of substrate material and thickness plays an important role in patch antenna design.

4.1 ANTENNA PARAMETERS AND THEIR SIGNIIFICANCE

The parameters of the antenna to be mentioned are

- (a) Bandwidth
- (b) Fractional Bandwidth
- (c) Antenna Gain
- (d) Gain Flatness
- (e) Aperture Efficiency

Bandwidth: the difference between the maximum and minimum frequency over which the return loss is less than -10dB.

$$BW = f_v - f_l$$

where f_v is the maximum frequency, f_l is the minimum frequency

Fractional bandwidth: The ratio of bandwidth to the central frequency is known as the impedance or fractional bandwidth.

$$\text{FBW} = \frac{f_v - f_l}{f_c}$$

where f_c is the centre frequency.

Antenna Gain: Gain (G) is the ratio of intensity of the radiation in a specified direction to the radiation intensity that obtained due to the power accepted by the antenna which radiates isotropically.

$$G = D \times \eta_e$$

The gain signifies the power transmitted in the direction of maximum radiation to that of an isotropic source. The antenna gain includes the losses that occur into account.

Gain Flatness: The difference in the maximum and minimum gain over the bandwidth. It should be less than 1 dB.

Aperture efficiency: it is the ratio of maximum effective aperture and physical aperture. Aperture efficiency (A_e) is given by

$$A_e = \frac{A_{em}}{A_p} = \frac{G_o \frac{\lambda^2}{4\pi}}{A_p}$$

Where A_p is physical dimensions of the antenna, A_{em} is maximum effective aperture, G_o is the peak gain of antenna and λ (5 mm) is free space wavelength.

4.2 MICROSTRIP PATCH ANTENNA

For the design of microstrip patch antenna, length and width of the antenna is to be calculated. These will get from the below formulae.

A Taconic TLY-5 whose permittivity (ϵ_r) and height (h) are 2.2 and 0.25 mm respectively is chosen as substrate material. Antenna is to be designed at f_o (= 60 GHz).

Width of the antenna is given by $W = \frac{c}{2 f_o \sqrt{\frac{\epsilon_r + 1}{2}}}$

Effective dielectric constant is given by $\epsilon_{eff} = \frac{\epsilon_r + 1}{2} + \frac{\epsilon_r - 1}{2} \left(1 + 12 \frac{h}{w}\right)^{-1/2}$

Effective length is given by $L_{eff} = \frac{c}{2 f_o \sqrt{\epsilon_{eff}}}$

Length extension is given by $\Delta L = 0.412h \frac{(\epsilon_{\text{eff}}+0.3) \left(\frac{w}{h}+0.264\right)}{(\epsilon_{\text{eff}}-0.258) \left(\frac{w}{h}+0.8\right)}$

Patch length is given by $L = L_{\text{eff}} - 2 \Delta L$.

Where, c is velocity of light.

By substituting the given values we get parameters as

$$W = 1.97642 \text{ mm}$$

$$\epsilon_{\text{eff}} = 1.97812$$

$$L_{\text{eff}} = 1.77751 \text{ mm}$$

$$\Delta L = 0.12801 \text{ mm}$$

$$L = 1.52 \text{ mm}$$

Antenna is designed based on these parameters. Ground and substrate dimensions must be larger than the patch dimensions. The antenna dimensions are taken as $4 \times 4 \text{ mm}^2$.

Table 4.1: Dimensions of microstrip patch antenna

Dimension	Value(mm)
L	1.52
W	1.976
L1	4
W1	4
TG	0.035
TS	0.25
TM	0.018

where L1 is length of antenna,

W1 is width of antenna,

L1 is length of antenna,

TG is thickness of ground,

TS is thickness of substrate,

TM is thickness of metal.

Steps to follow to design an antenna

1. Ground plane with dimensions $L1 \times W1 \times TG$ and PEC material is taken.

2. Substrate with dimensions $L1 \times W1 \times TS$ and TLY-5 material is taken.
3. Patch with dimensions $L \times W \times TM$ and Cu material is taken.

This is the design of microstrip antenna.

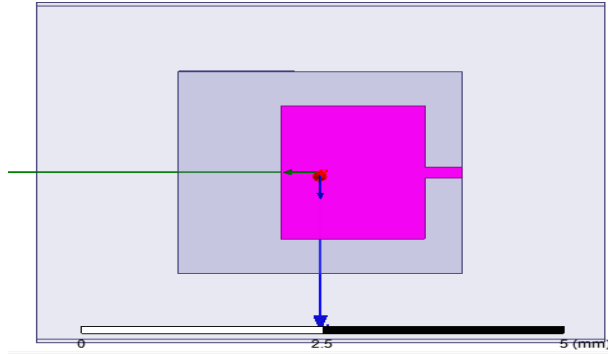

Figure 4.1: Microstrip patch antenna design in HFSS

To find the bandwidth of the antenna S11 has to be found out. The S11 of the antenna will be

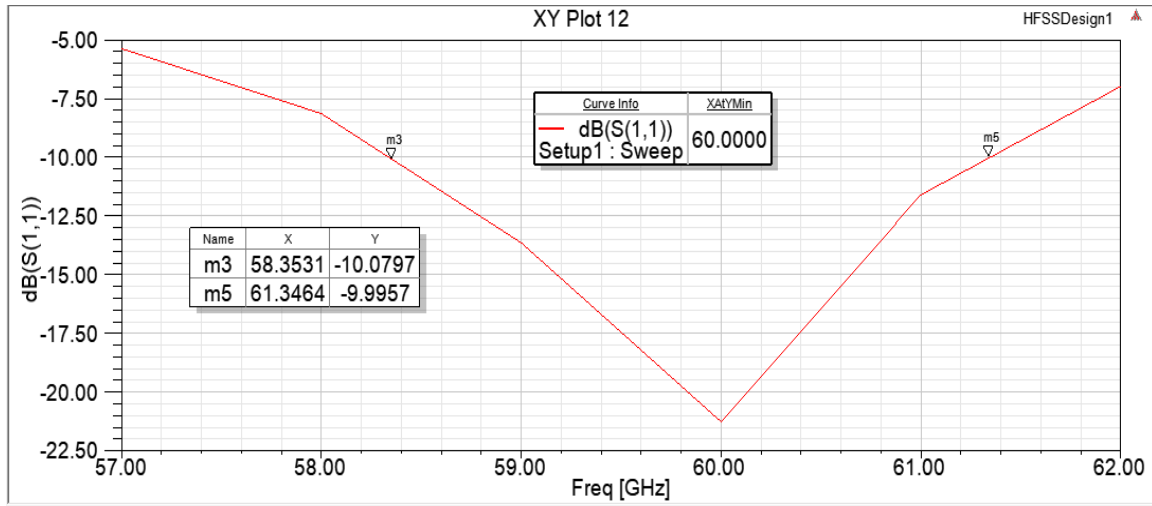

Figure 4.2: Return loss of designed Microstrip patch antenna

The two points in the graph are m3 and m5. They denote the frequency at which S11 is less than -10 dB or VSWR less than 2. The bandwidth of the designed antenna is $m5 - m3 = 2.9933$ GHz. The resonant frequency is at 60 GHz.

$$\text{Impedance bandwidth} = \frac{m5 - m3}{60} \times 100\% = 5\%.$$

The gain of the antenna is as follows

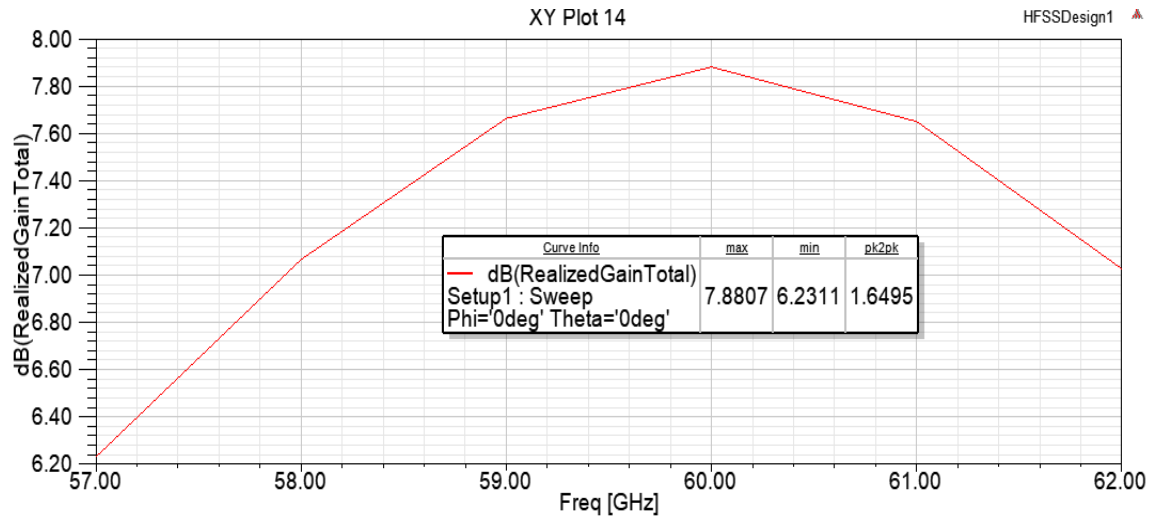

Figure 4.3: Microstrip patch antenna gain in dB

The maximum and minimum gain is 7.8807 dB and 6.2311 dB respectively. So gain flatness is 1.6495 dB.

The E plane radiation pattern will be

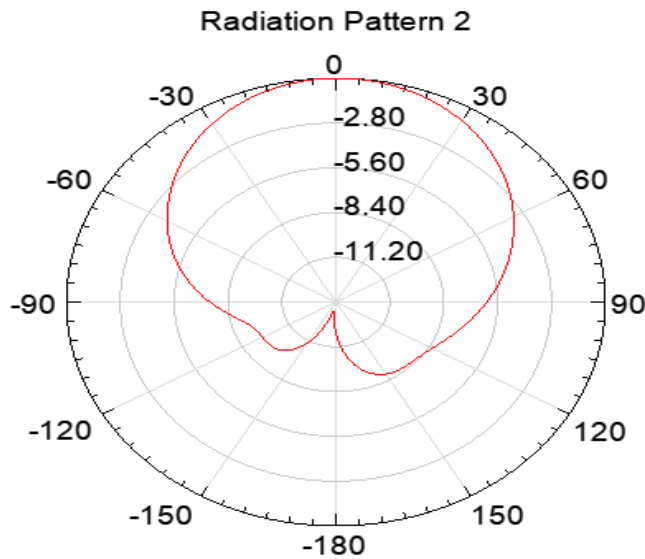

Figure 4.4: E plane radiation pattern of microstrip patch antenna at 60 GHz
HPBW of E plane radiation is 112°.

The H plane radiation pattern will be

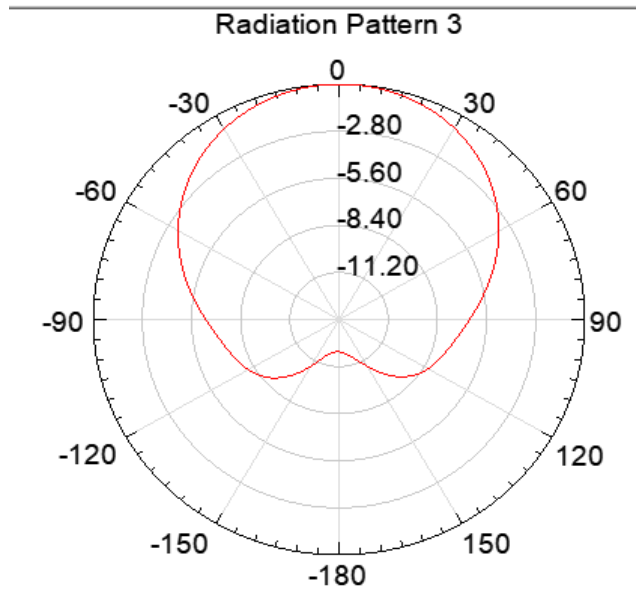

Figure 4.5: H plane radiation pattern of microstrip patch antenna at 60 GHz
HPBW of H plane radiation is 111°.

For the calculations of aperture efficiency, the gain is to be found out without any units.
The peak gain of the antenna is calculated by from the graph.

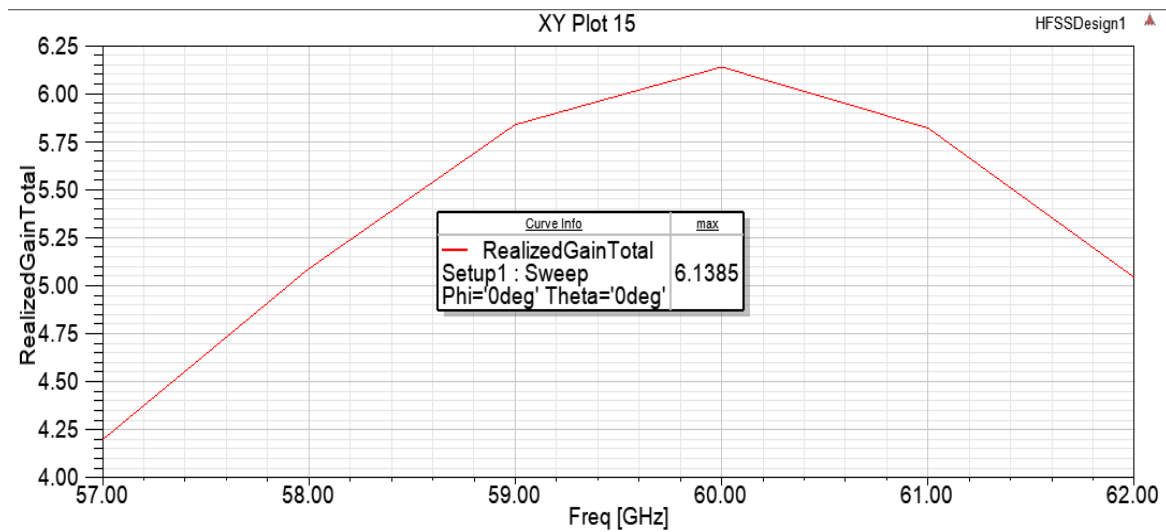

Figure 4.6: Microstrip patch antenna gain

From the graph the peak gain of the antenna is 6.1385.

The aperture efficiency over the frequencies is given by

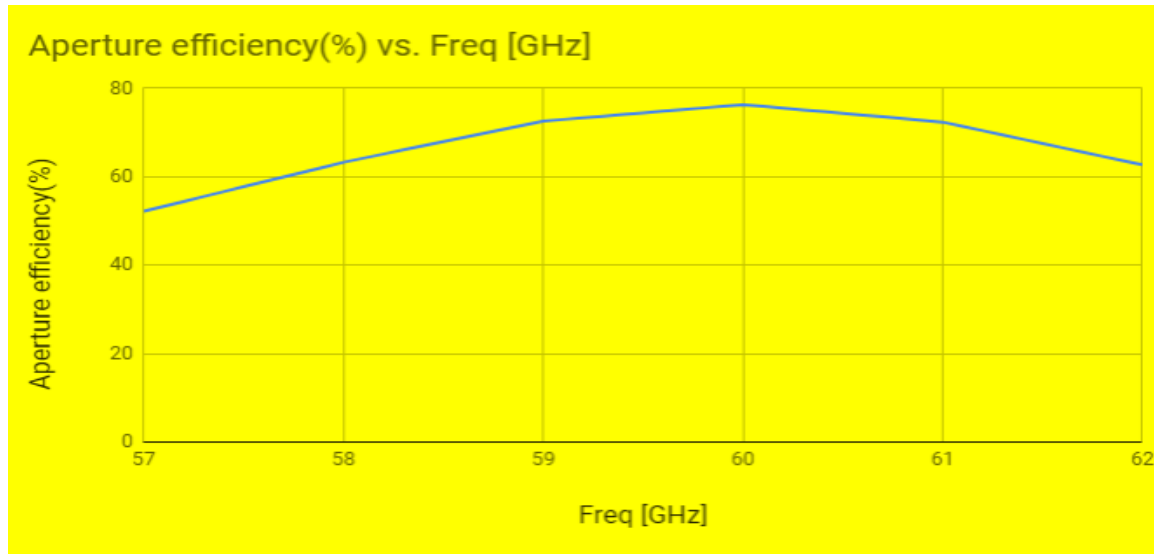

Figure 4.7: Aperture efficiency of the microstrip patch antenna

The maximum aperture efficiency is 76.5% at 60 GHz.

Table 4.2: The overall parameters of the antenna

Parameter	Value
Bandwidth	2.99 GHz
Impedance Bandwidth in %	5
Peak Gain	7.88 dB
Gain Flatness	1.64 dB
Aperture Efficiency	76.5%

From the above table the bandwidth is less when compared to the desired bandwidth which is from 57 GHz to 64GHz. Due to this data transfer will be low. Peak gain is also low indicating power is not concentrated in main beam. Aperture efficiency is more indicating more power is received by the antenna.

So to overcome this entire E shaped patch antenna is designed.

4.3 E SHAPED PATCH ARRAY ANTENNA

The discussion on E shaped patch antenna is done in chapter 1. The bottom and top parts of patch antenna gets current from the feeding point. So the LC resonant circuit can be drawn for a microstrip patch antenna. But in the patch, containing slots, current flows like normal patch at the center and in the slots it flows around them changing current path length. The additional inductance is added to the previous inductance. As the inductance value increases [34] the resonant frequency will decrease, so the slots will resonate at low frequencies. The bandwidth gets wider [12] due to this. The equivalent circuits for microstrip patch antenna is given by

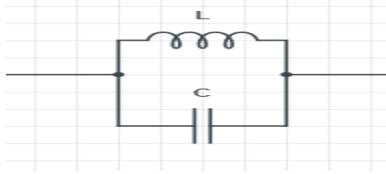

Figure 4.8: Equivalent circuit of microstrip patch antenna

The equivalent circuits for E shaped patch antenna is given by

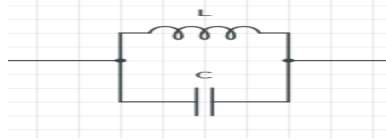

Figure 4.9: Equivalent circuit of center part of E shaped patch antenna

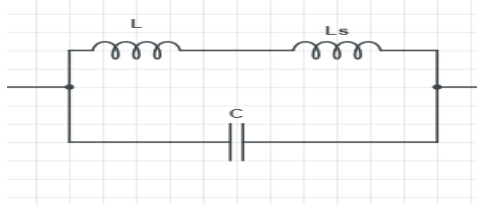

Figure 4.10: Equivalent circuit of top and bottom slots of E shaped patch antenna

There will be two resonant frequencies named as f_h and f_l . These two frequencies are given by

$$f_h = \frac{C_0}{2 \times (\Delta L \times L_0) \times \sqrt{\epsilon_r}} \text{ and } f_l = \frac{C_0}{2 \times (2 \times L_0 + W_2 - \Delta L - L_2) \times \sqrt{\epsilon_r}}$$

Where C_0 is velocity of light, ϵ_r is relative permittivity, W is width of the total patch. If the two frequencies are closer to each other then antenna gain increases and wideband will come.

4.2.1 E SHAPED PATCH ANTENNA WITH NO ARRAY

An E shaped patch antenna [12] is to be designed at 60 GHz using the above parameters and formulae. The parameters of the middle patch are same as above microstrip patch antenna. The slots dimensions will get from the f_h and f_l equations.

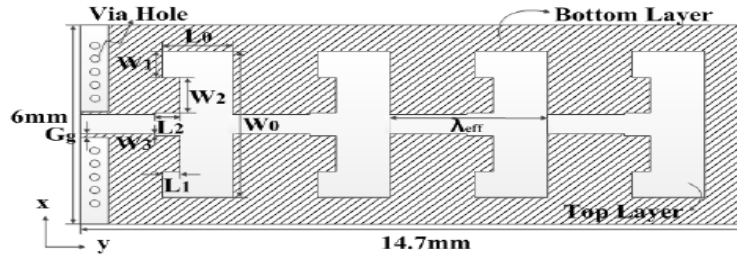

Fig 4.11: E shaped patch antenna array showing dimensions

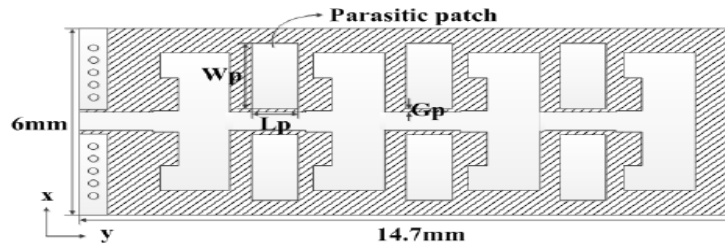

Fig 4.12: E shaped patch antenna array with parasitic patches showing dimensions

Table 4.3: Dimensions of E shaped patch antenna

Dimension	Value in mm	Dimension	Value in mm
W	6	λ_{eff}	3.27
T_G	0.035	W_0	4.4
T_s	0.25	W_1	0.79
T_M	0.018	W_2	1.06
ϵ_r	2.2 (no units)	W_3	0.06
W_p	2.1	G_p	0.1
L_p	1.2	L_0	1.55
L_1	0.4	L_2	0.58
W_p	2.1	G_g	0.13
l_1	3.675	l_2	7.35
l_3	11.625	l_4	14.7

Based on these parameters an E shaped patch antenna is designed [5] in HFSS.

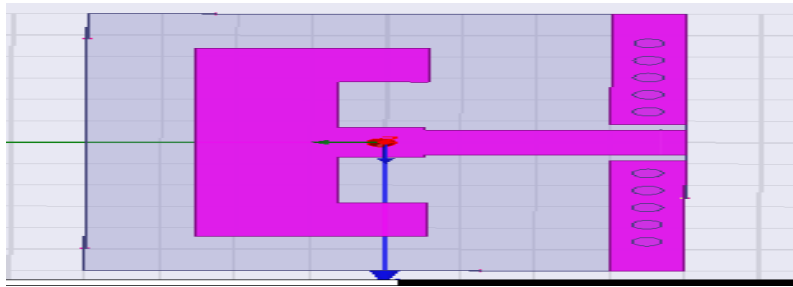

Figure 4.13: E shaped patch antenna with no array

The return loss of the antenna is

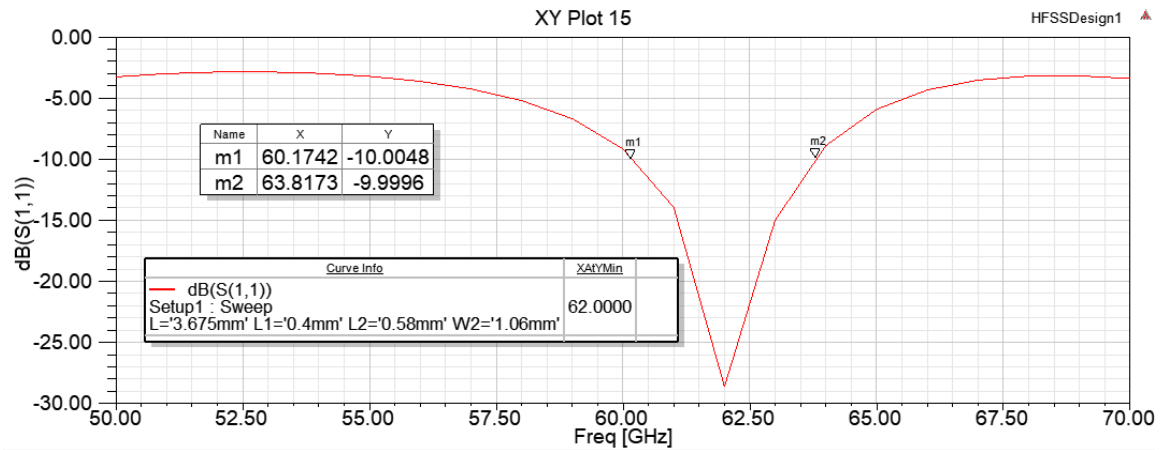

Figure 4.14: Return loss of E shaped patch antenna with no array

The antenna bandwidth is $m2 - m1 = 3.6449$ GHz. The resonant frequency is at 62 GHz.

Impedance bandwidth = $\frac{m2 - m1}{62} \times 100\% = 5.88\%$.

The antenna gain will be

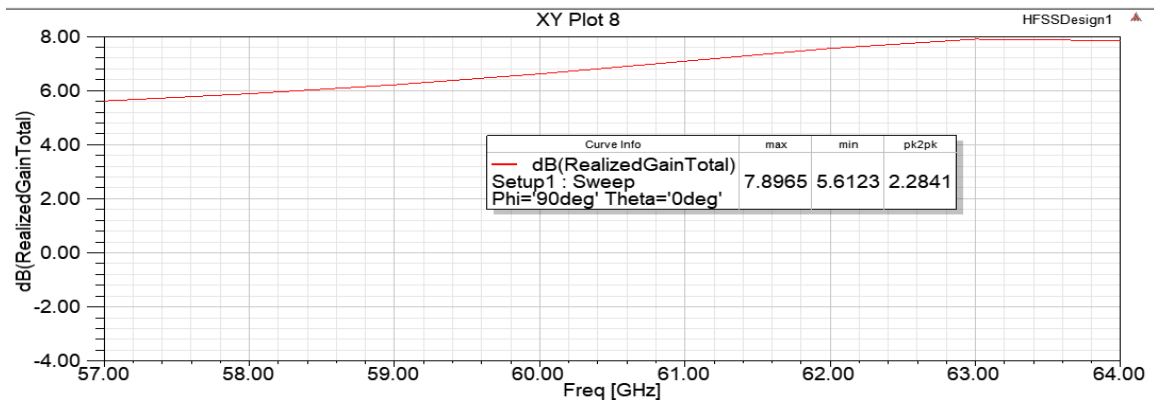

Figure 4.15: E shaped patch antenna with no array gain in dB

From the graph the peak gain on the antenna is 7.8965 dB. The gain flatness is 2.2841 dB.

The E plane radiation pattern is

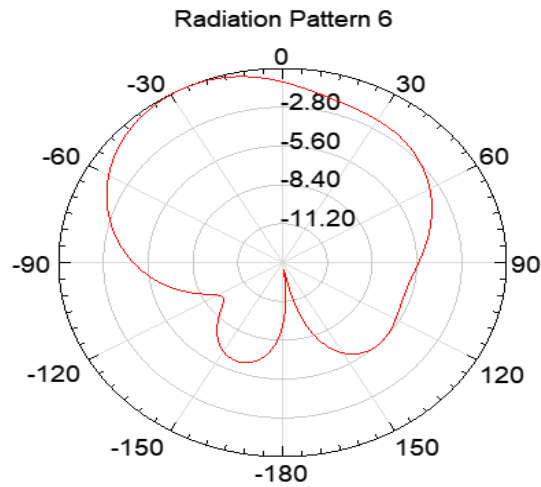

Figure 4.16: E plane radiation pattern of E shaped patch antenna with no array at 60 GHz
HPBW of E plane pattern is 131° .

The H plane radiation pattern is

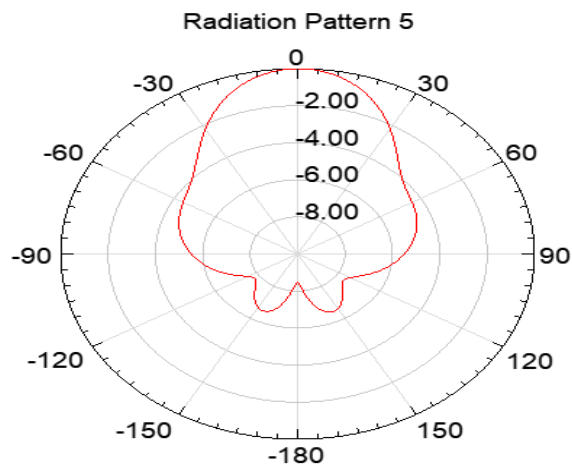

Figure 4.17: H plane radiation pattern of E shaped patch antenna with no array at 60 GHz
From the figure, HPBW of H plane is 72° .

The realized gain on the antenna is

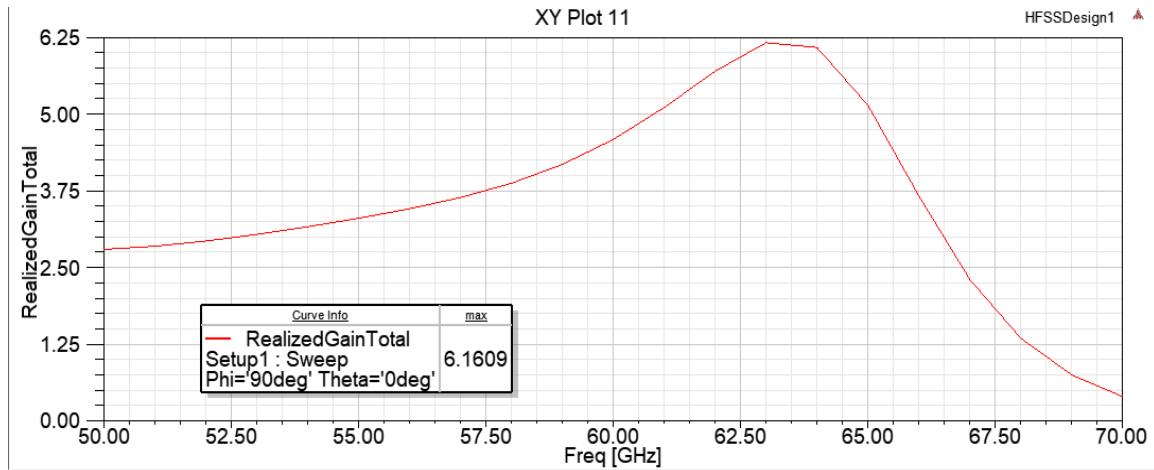

Figure 4.18: Realized gain of E shaped patch antenna with no array

From this realized gain the aperture efficiency is found out and the graph is drawn on how aperture efficiency changes with frequency.

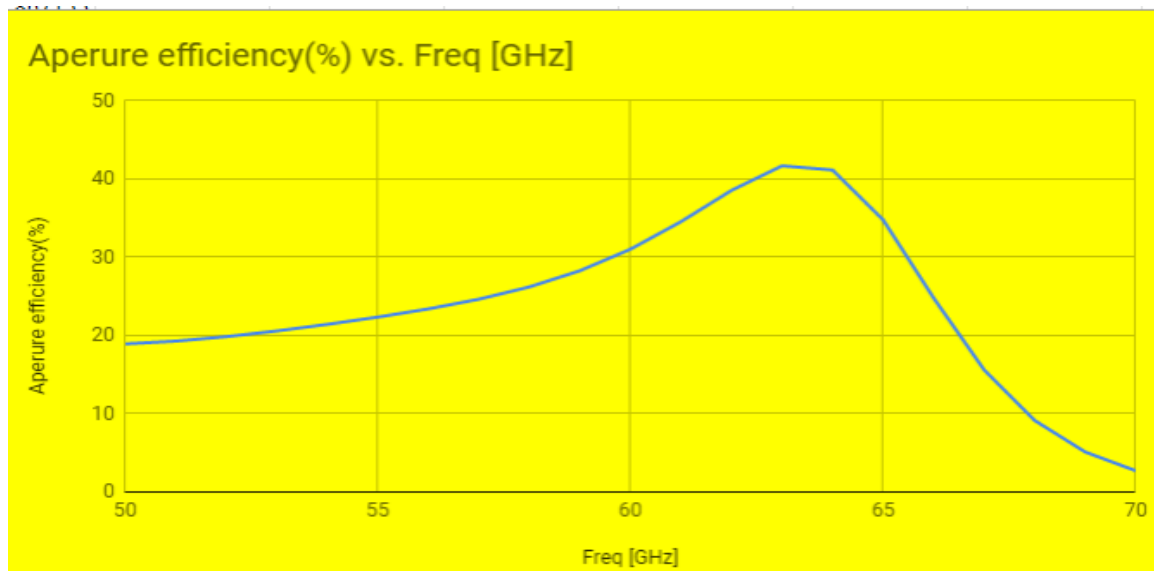

Figure 4.19: Aperture Efficiency of E shaped patch antenna with no array

From the graph, the aperture efficiency is high at 63 GHz and the value is 41.67%.

4.3.2 E SHAPED PATCH ANTENNA WITH ONE ARRAY WITHOUT PARASITIC PATCHES

From the above results, bandwidth, peak gain and gain flatness must be improved. So to this two E shaped patches are connected in series. They may also be connected in parallel

but the series array antennas are easy to fabricate and an extra feed is required but there is shift in frequency of the beam direction offset at E plane. The elements are adjusted to increase radiation efficiency. There is loss of energy while travelling from one element to other element, so radiation efficiency is less in series fed antennas. The dimensions are same as above antenna. The array size is increased to 4 in a linear way and from the results the antenna with desired parameters is to be taken for fabrication. The E shaped patch antenna with one array will be as shown

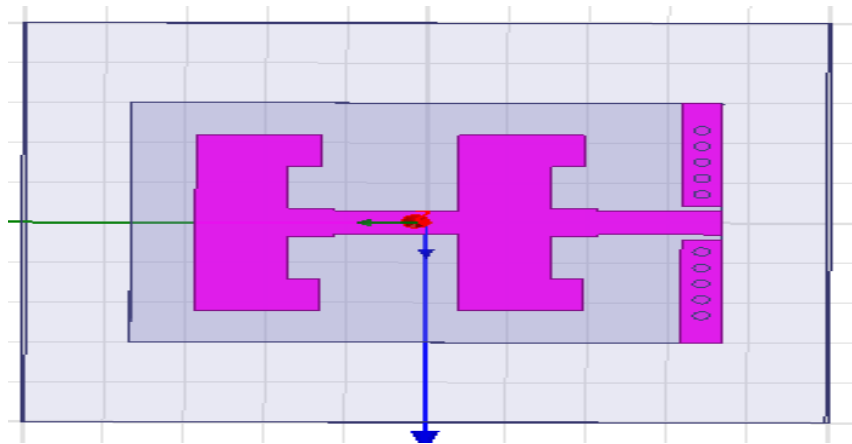

Figure 4.20: One array E shaped patch antenna without parasitic patches

The return loss of the antenna is

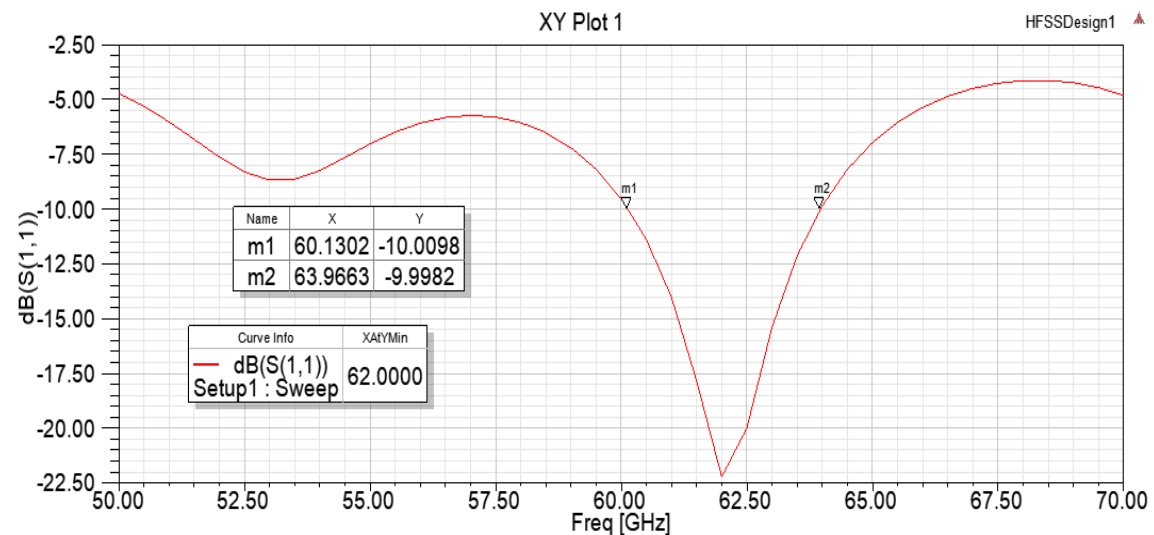

Figure 4.21: Return loss of one array E shaped patch antenna without parasitic patches
From the figure the bandwidth is $m2-m1 = 3.8361$ GHz. Resonant frequency is 62 GHz.

$$\text{Impedance bandwidth} = \frac{m2-m1}{62} \times 100\% = 6.18\%.$$

The antenna gain in dB will be

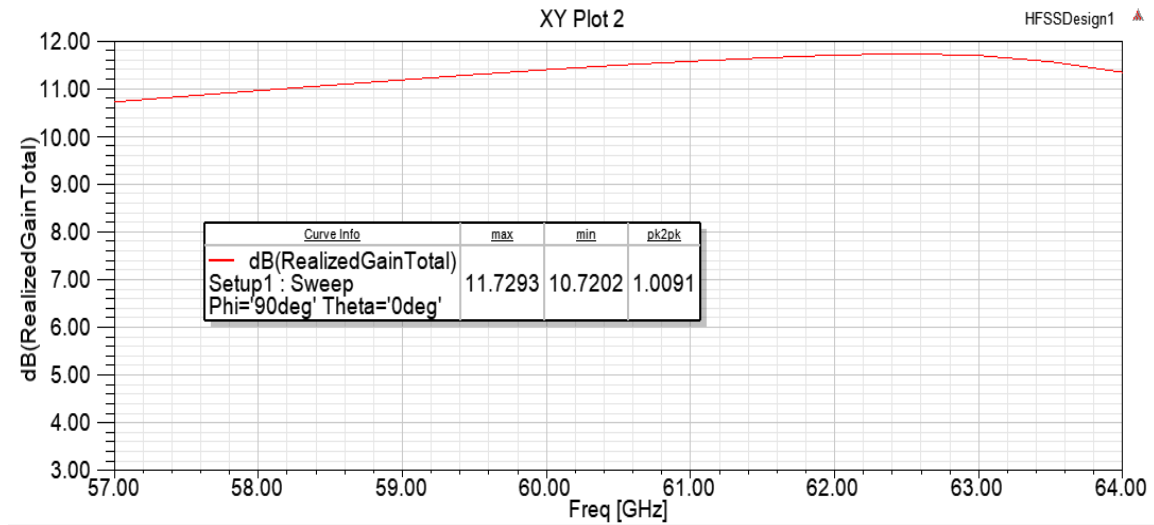

Figure 4.22: Gain of one array E shaped patch antenna without parasitic patches
 The peak gain of the antenna is 11.7293 dB. The gain flatness is 1.0091 dB.

The E plane radiation pattern is

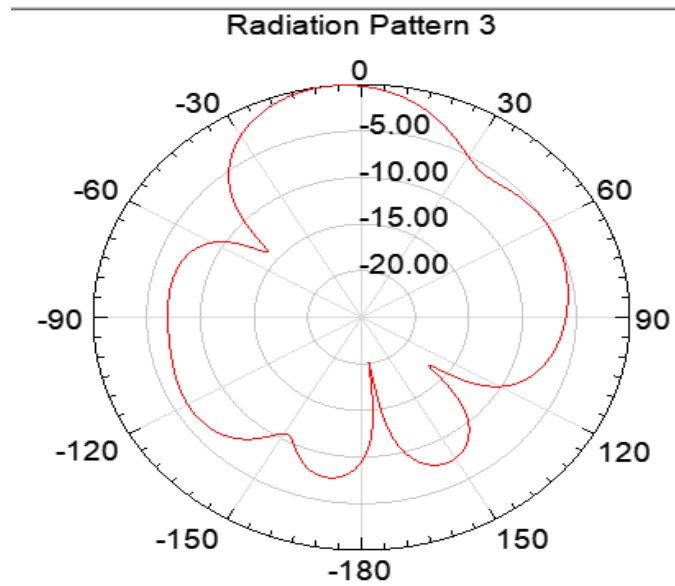

Figure 4.23: E plane radiation pattern of one array E shaped patch antenna without parasitic patches at 60 GHz

From the figure, HPBW of E plane pattern is 40° .

The H plane radiation pattern is

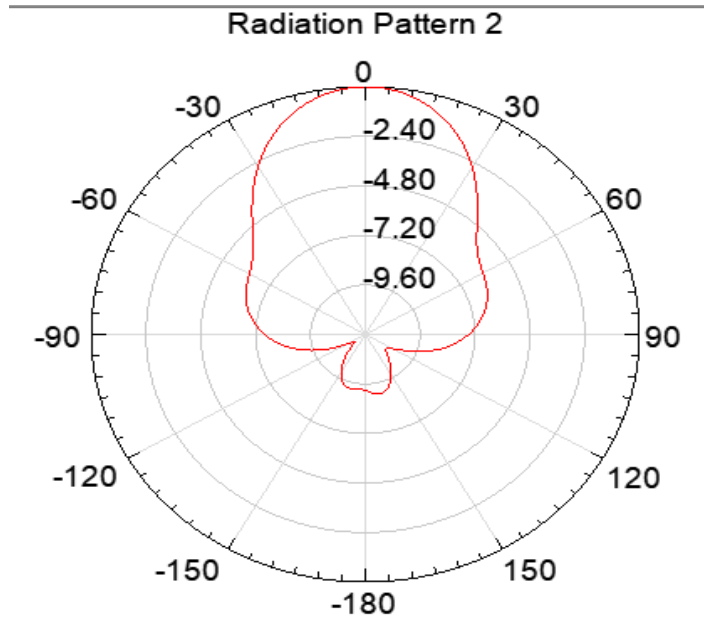

Figure 4.24: H plane radiation pattern of one array E shaped patch antenna without parasitic patches at 60 GHz

From the figure, HPBW of H plane is 20°.

The realized gain on the antenna is

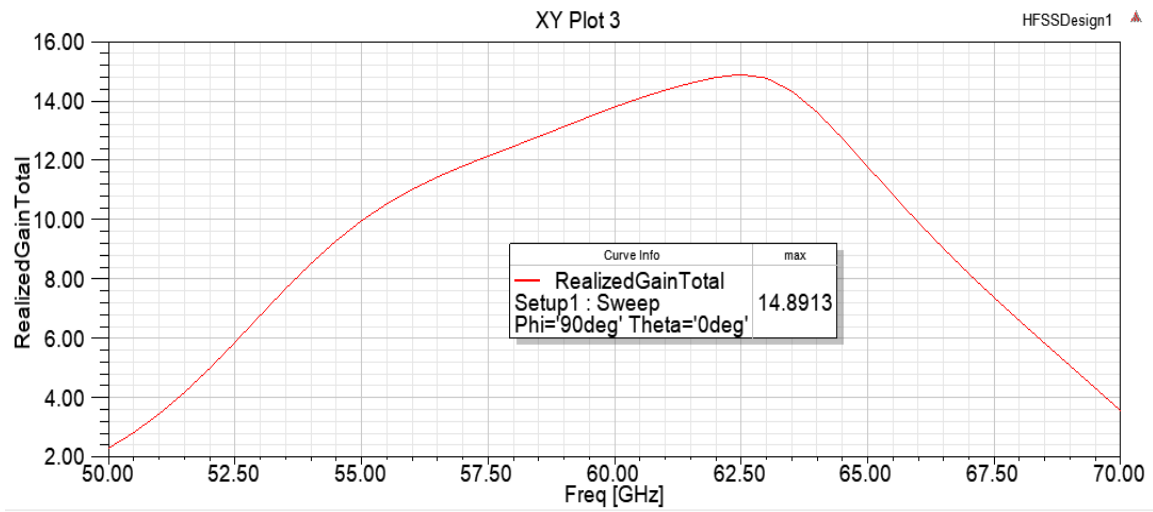

Figure 4.25: Antenna gain of one array E shaped patch antenna without parasitic patches
From this realized gain the aperture efficiency is found out and the graph is drawn on how aperture efficiency changes with frequency.

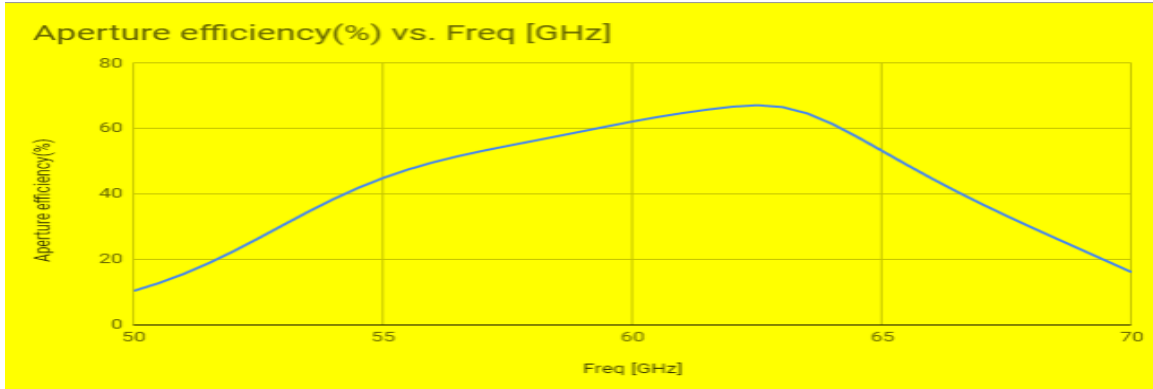

Figure 4.26: Aperture Efficiency of one array E shaped patch antenna without parasitic patches

From the graph, the aperture efficiency is high at 62.5 GHz and the value is 67.15%.

4.3.3 E SHAPED PATCH ANTENNA WITH ONE ARRAY WITH PARASITIC PATCHES

The advantages of having parasitic patches is discussed in chapter 2. the E shaped patch Antenna with one array with parasitic patches will be as shown

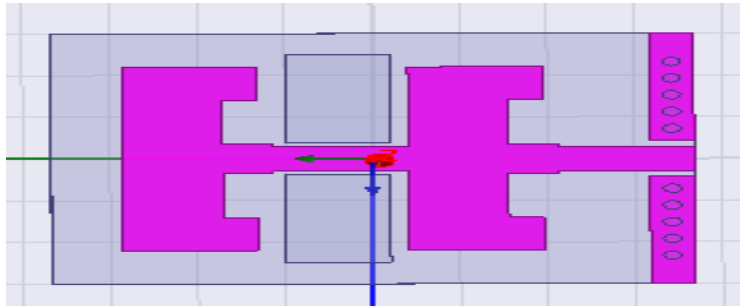

Figure 4.27: One array E shaped patch antenna with parasitic patches

The return loss of the antenna is

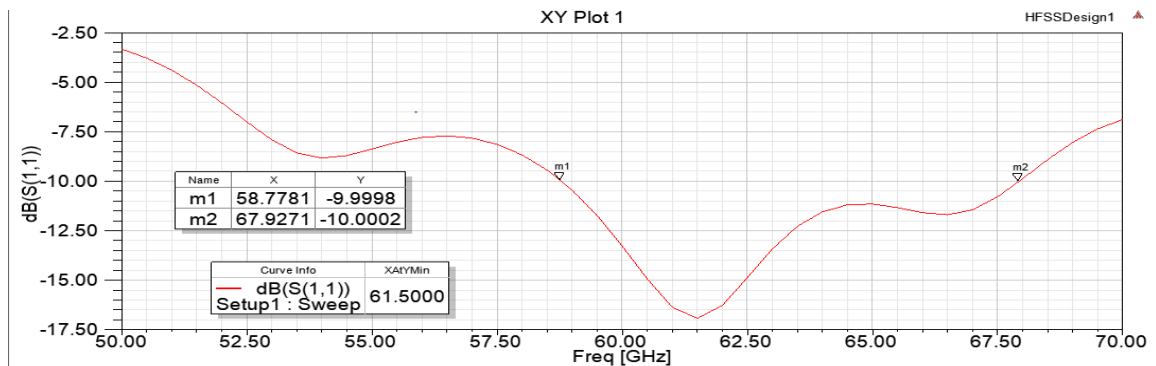

Figure 4.28: Return loss of one array E shaped patch antenna with parasitic patches

From the figure the bandwidth is $m_2 - m_1 = 9.149$ GHz. Resonant frequency of 61.5 GHz.

$$\text{Impedance Bandwidth} = \frac{m_2 - m_1}{61.5} \times 100\% = 14.87\%.$$

The antenna gain will be

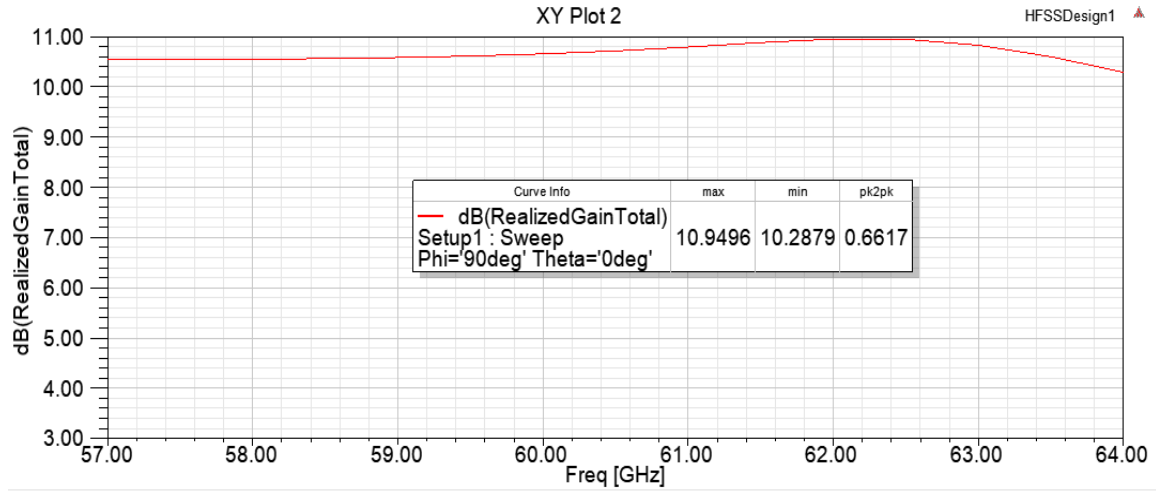

Figure 4.29: Gain of one array E shaped patch antenna with parasitic patches

The peak gain of the antenna is 10.9496 dB. The gain flatness is 0.6617 dB.

The E plane radiation pattern is

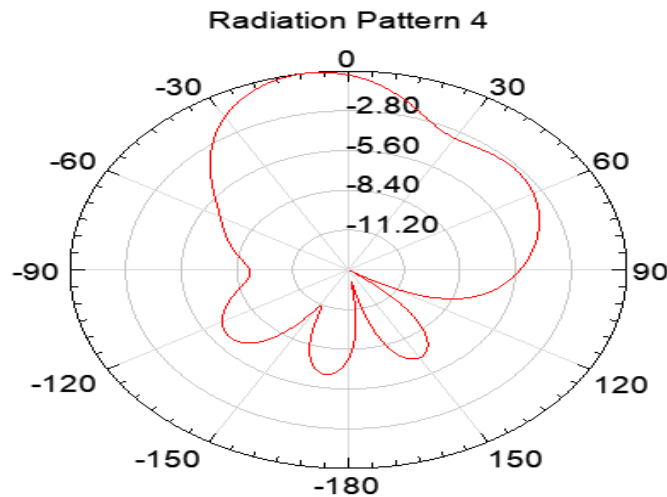

Figure 4.30: Gain of one array E shaped patch antenna with parasitic patches at 60 GHz

From the figure, HPBW of E plane pattern is 46° .

The H plane radiation pattern is

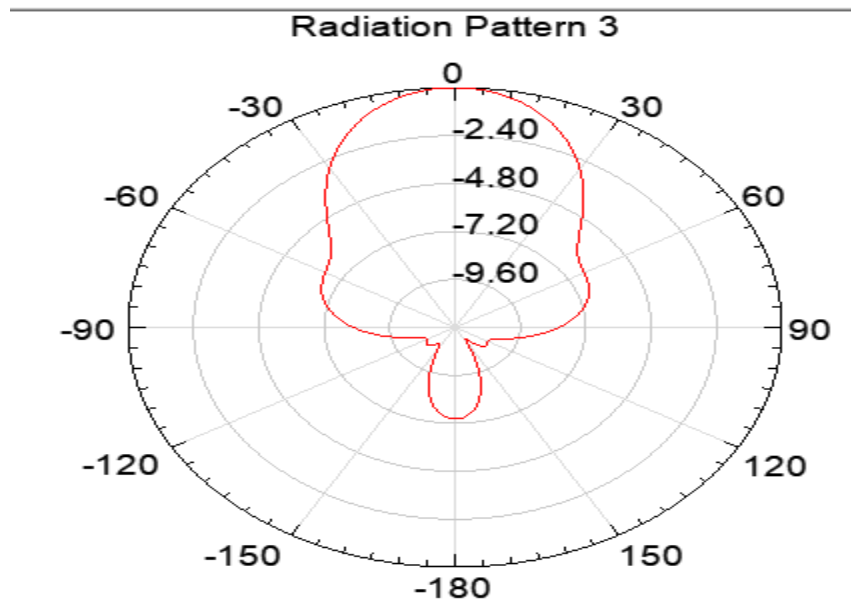

Figure 4.31: Gain of one array E shaped patch antenna with parasitic patches at 60 GHz
From the figure, HPBW of H plane is 60°.

The realized gain on the antenna is

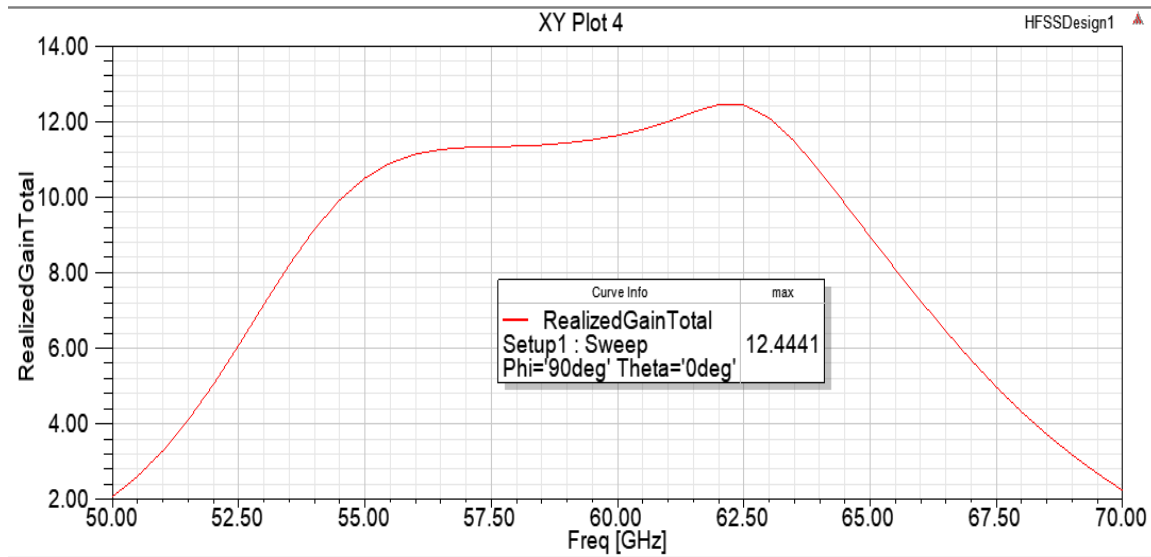

Figure 4.32: Gain of one array E shaped patch antenna with parasitic patches
Peak gain of the antenna is 12.4441.

From this realized gain the aperture efficiency is found out and the graph is drawn on how aperture efficiency changes with frequency.

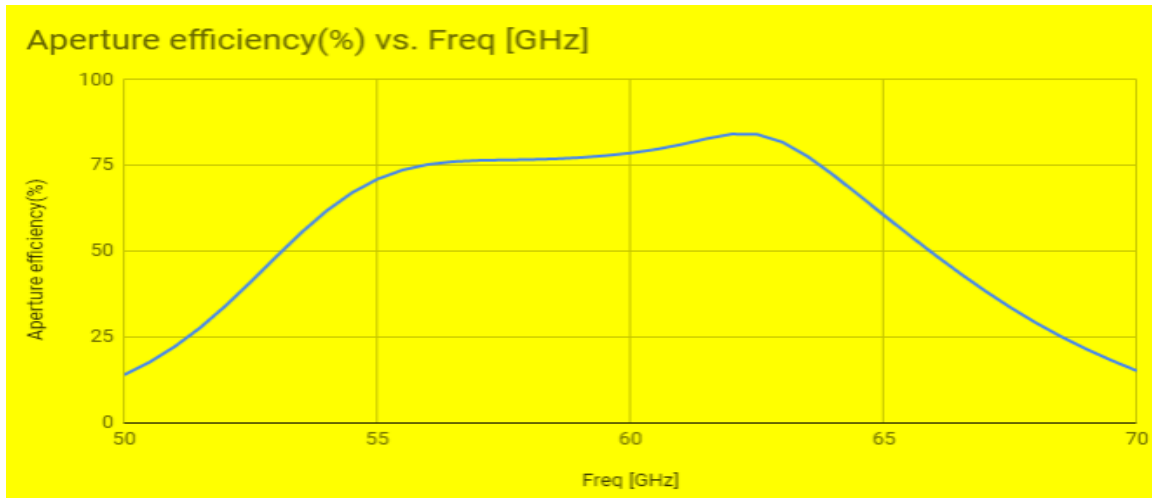

Figure 4.33: Aperture efficiency of one array E shaped patch antenna with parasitic patches

From the graph, the aperture efficiency is high at 62 GHz and the value is 84.17%.

4.3.4 E SHAPED PATCH ANTENNA WITH TWO ARRAY WITHOUT PARASITIC PATCHES

The E shaped patch antenna with two arrays without parasitic patches will be as shown

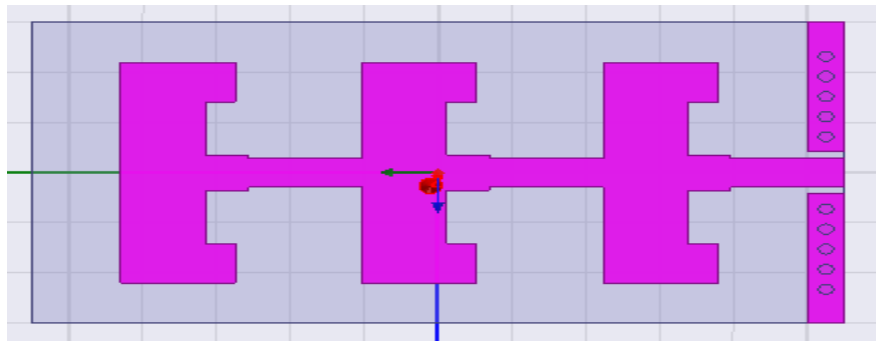

Figure 4.34: Two array E shaped patch antenna without parasitic patches

The return loss of the antenna is

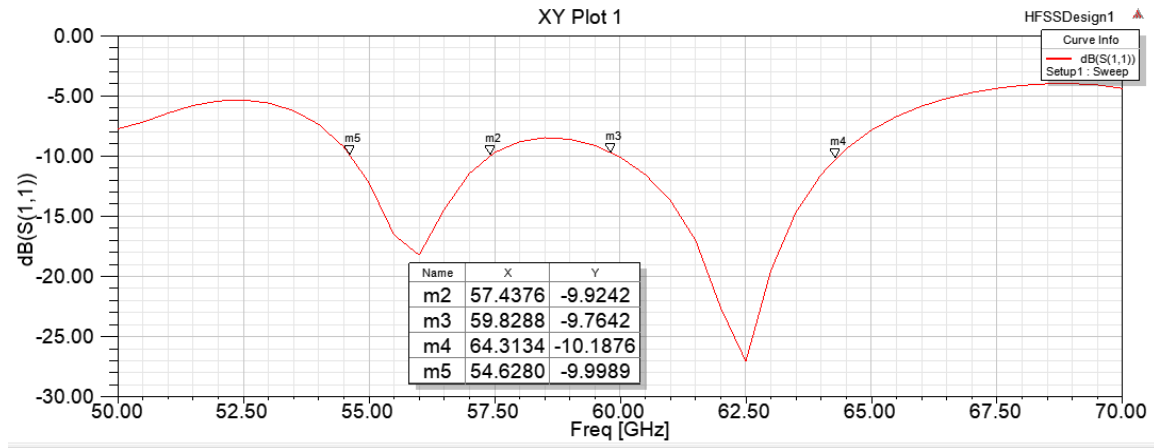

Figure 4.35: Return loss of two array E shaped patch antenna without parasitic patches
 The bandwidth of this antenna is $m5-m2+m4-m3 = 7.2942$ GHz. The resonant frequency is 56 GHz.

$$\text{Impedance bandwidth} = \frac{m5-m2+m4-m3}{56} = 13.02\%$$

The antenna gain will be

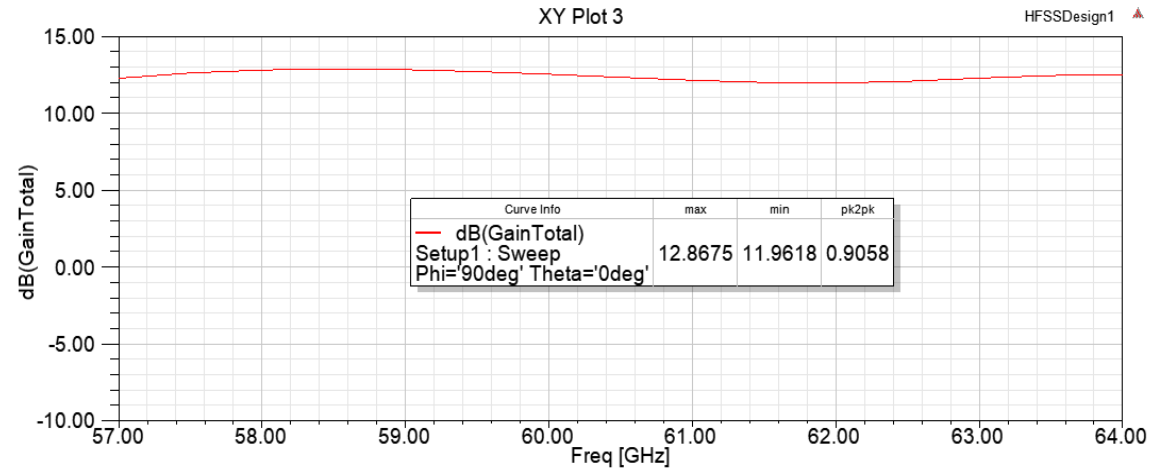

Figure 4.36: Gain in dB of two array E shaped patch antenna without parasitic patches
 The peak gain of the antenna is 12.8675 dB. The gain flatness is 0.9058 dB.

The E plane radiation pattern is

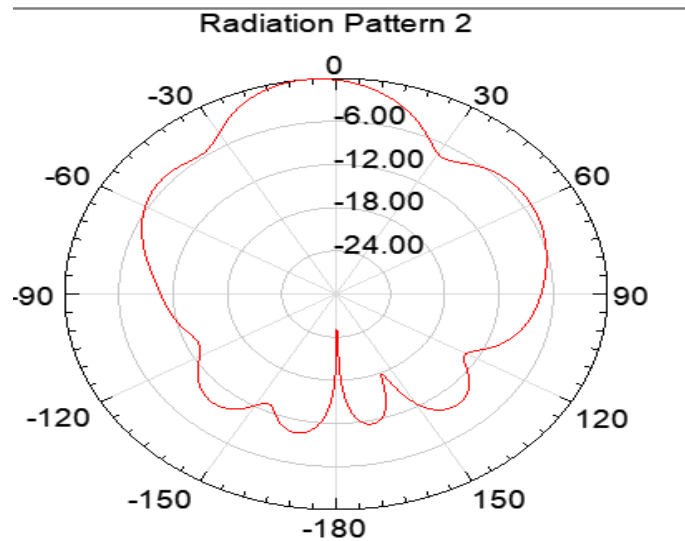

Figure 4.37: E plane radiation pattern of two array E shaped patch antenna without parasitic patches at 60 GHz

From the figure, HPBW of E plane pattern is 32° .

The H plane radiation pattern is

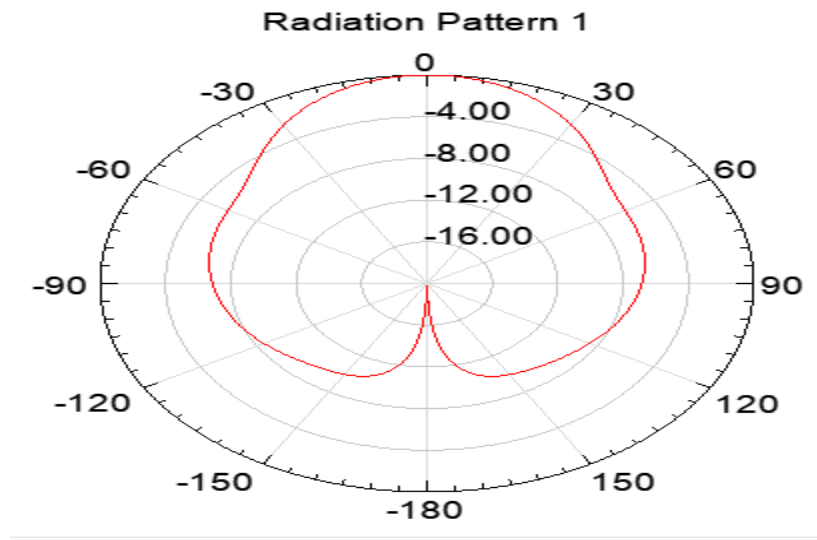

Figure 4.38: H plane radiation pattern of two array E shaped patch antenna without parasitic patches at 60GHz

From the figure, HPBW of H plane is 68° .

The realized gain on the antenna is

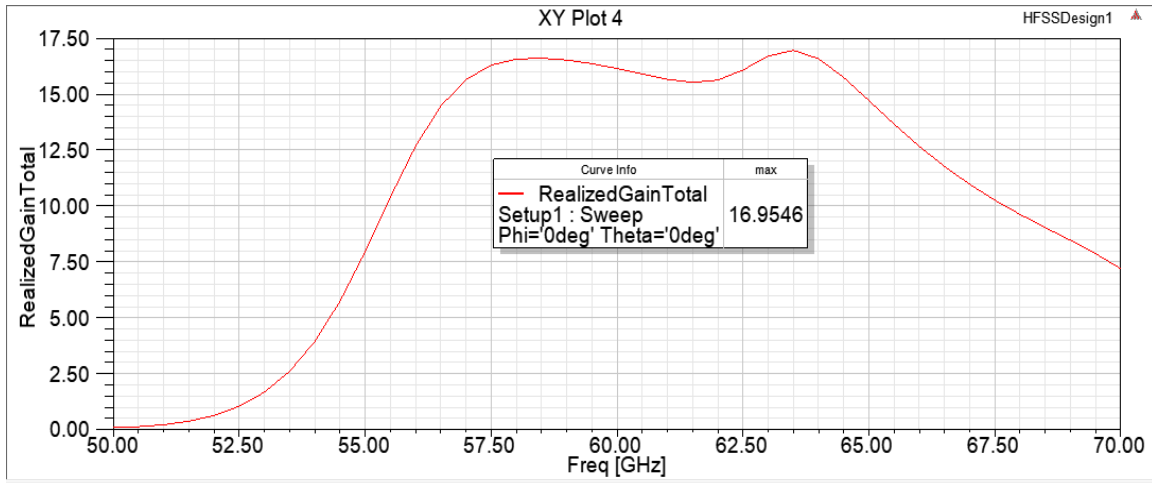

Figure 4.39: Realized gain of two array E shaped patch antenna without parasitic patches

The Peak gain of the antenna is 16.9546.

From this realized gain the aperture efficiency is found out and the graph is drawn on how aperture efficiency changes with frequency.

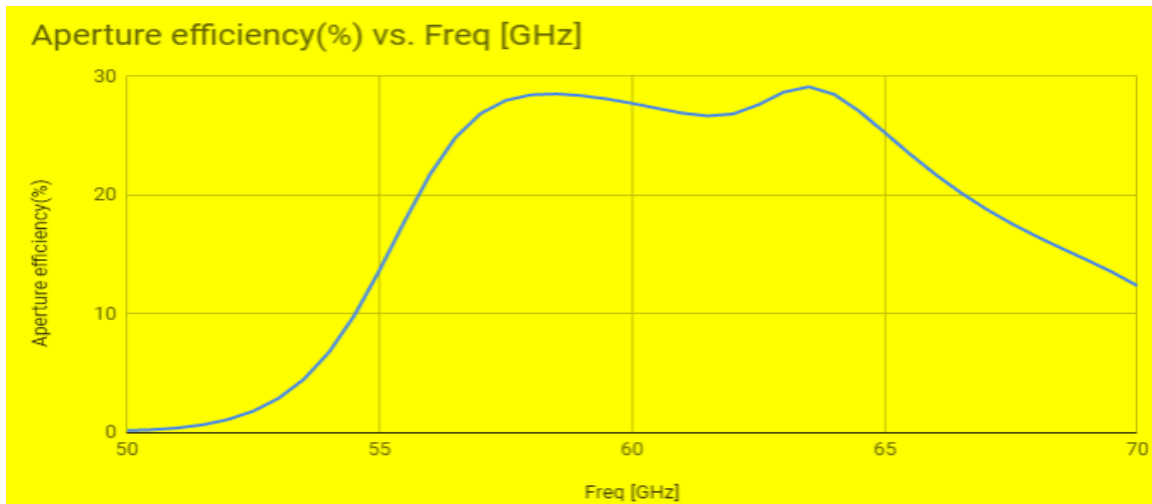

Figure 4.40: Aperture efficiency of two array E shaped patch antenna without parasitic patches

From the graph, the aperture efficiency is high at 58.5 GHz and the value is 28.54%.

4.2.5 E SHAPED PATCH ANTENNA WITH TWO ARRAY WITH PARASITIC PATCHES

The E shaped patch antenna with two array with parasitic patches will be as shown

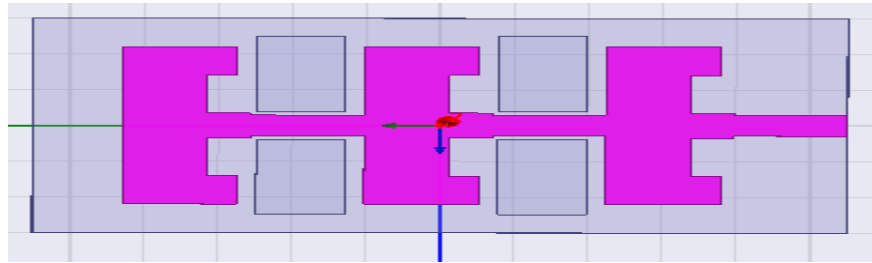

Figure 4.41: Two array E shaped patch antenna with parasitic patches

The return loss of the antenna is

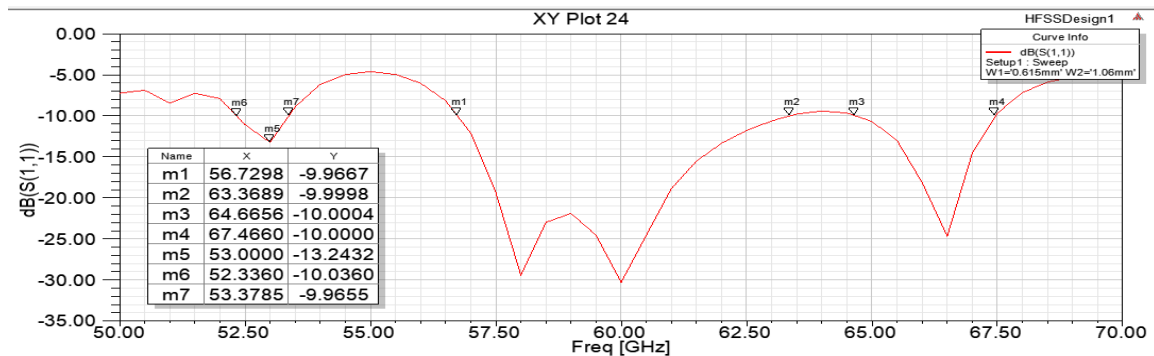

Figure 4.42: Return loss of two array E shaped patch antenna with parasitic patches

The bandwidth = $m2 - m1 + m4 - m3 + m7 - m6 = 10.8$ GHz and resonant frequency is 53 GHz.

$$\text{Impedance bandwidth} = \frac{m1 - m1 + m4 - m3 + m7 - m6}{53} \times 100\% = 20.28\%.$$

The antenna gain will be

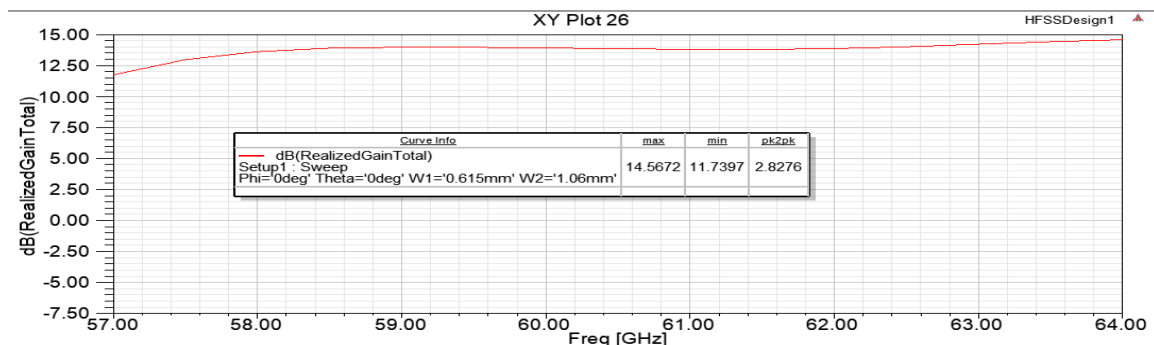

Figure 4.43: Gain in dB of two array E shaped patch antenna with parasitic patches

From the graph the peak gain is 14.5672 dB. The gain flatness is 2.8276 dB.

The E plane radiation pattern is

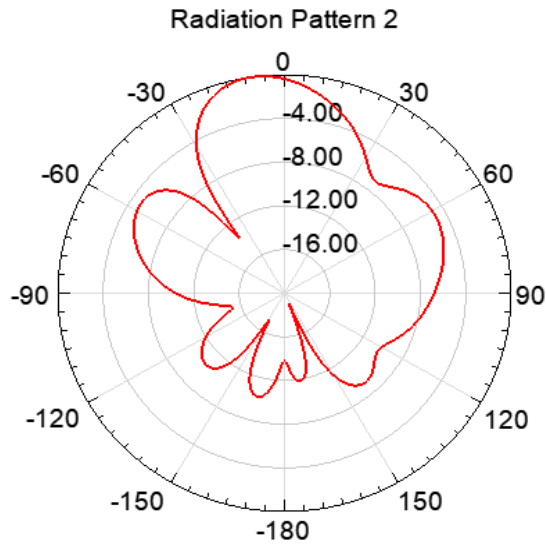

Figure 4.44: E plane radiation pattern of two array E shaped patch antenna with parasitic patches at 60 GHz

From the figure, HPBW of E plane pattern is 32° .

The H plane radiation pattern is

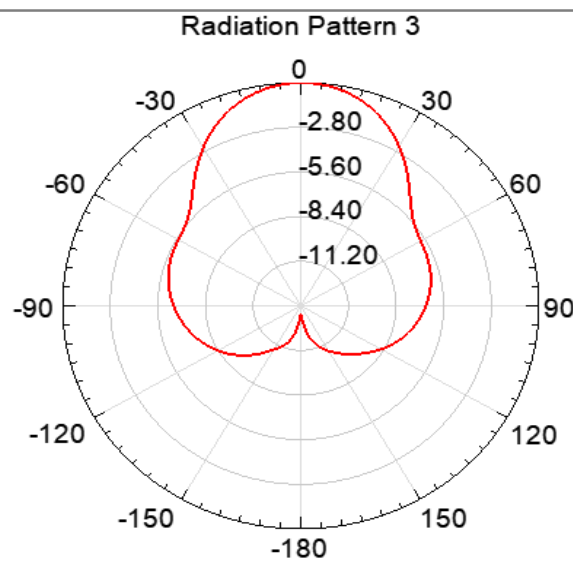

Figure 4.45: H plane radiation pattern of two array E shaped patch antenna with parasitic patches at 60 GHz

From the figure, HPBW of H plane is 68° .

The realized gain on the antenna is

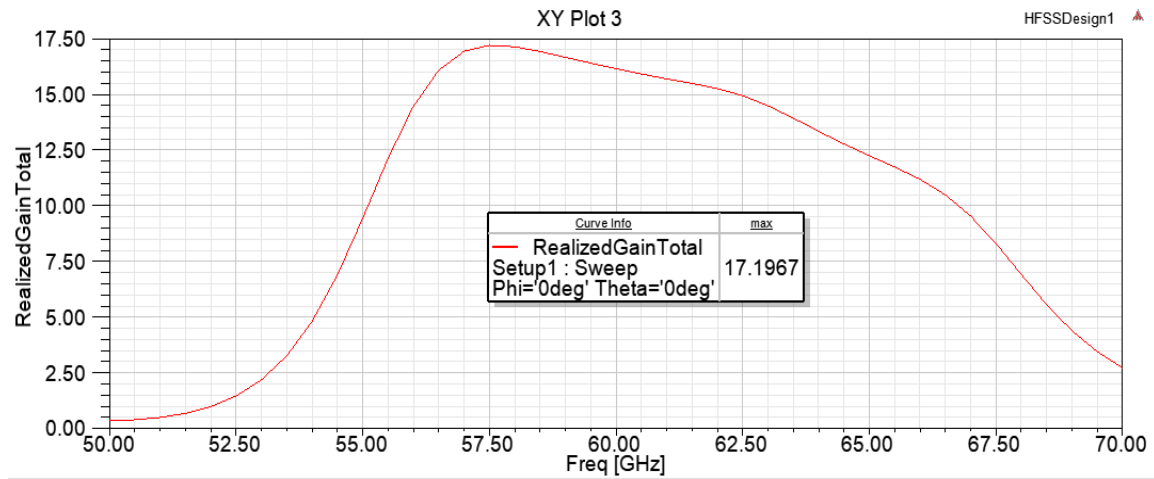

Figure 4.46: Gain of two array E shaped patch antenna with parasitic patches
Peak gain is 17.1967.

From this realized gain the aperture efficiency is found out and the graph is drawn on how aperture efficiency changes with frequency.

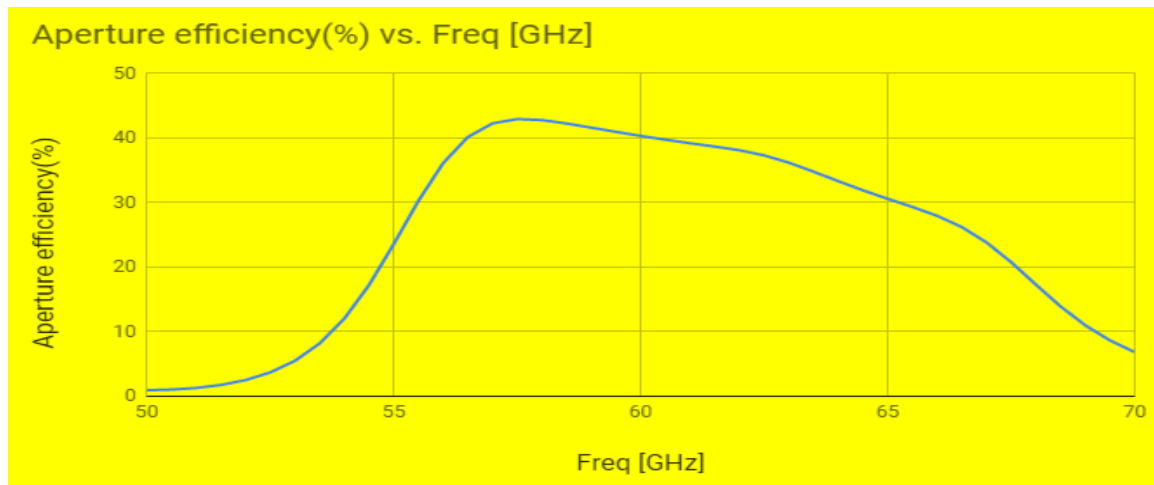

Figure 4.47: Aperture efficiency of two array E shaped patch antenna with parasitic patches

From the graph, the aperture efficiency is high at 58.2 GHz and the value is 42.93%.

4.3.6 E SHAPED PATCH ANTENNA WITH THREE ARRAY WITHOUT PARASITIC PATCHES

The E shaped patch antenna with three array without parasitic patches is shown below

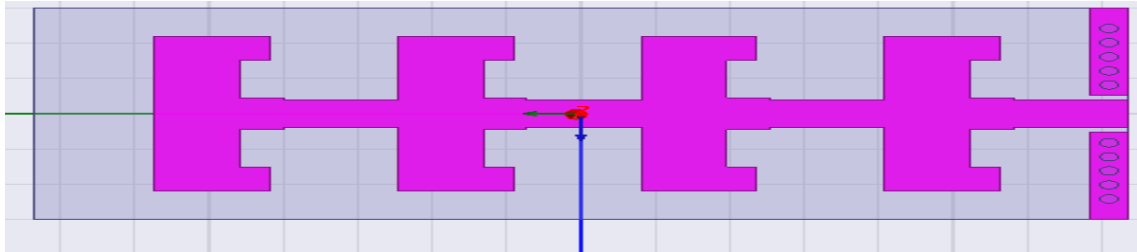

Figure 4.48: Three array E shaped patch antenna without parasitic patches

The return loss of the antenna is

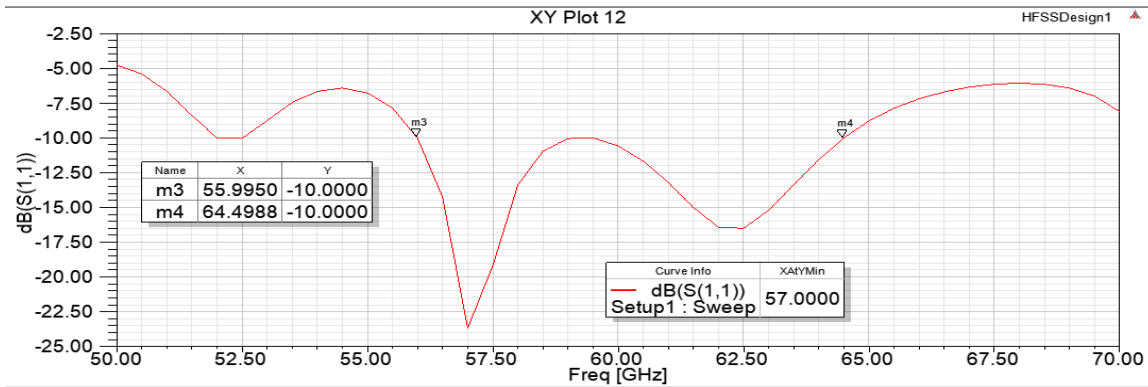

Figure 4.49: Return loss of three array E shaped patch antenna without parasitic patches

From the figure the bandwidth is $m4 - m3 = 8.5038$ GHz.

The resonant frequency is 57 GHz. But the first resonance came at 51.75 GHz.

$$\text{Impedance bandwidth} = \frac{64.4988 - 51.75}{52} \times 100\% = 24.51\%$$

The antenna gain will be

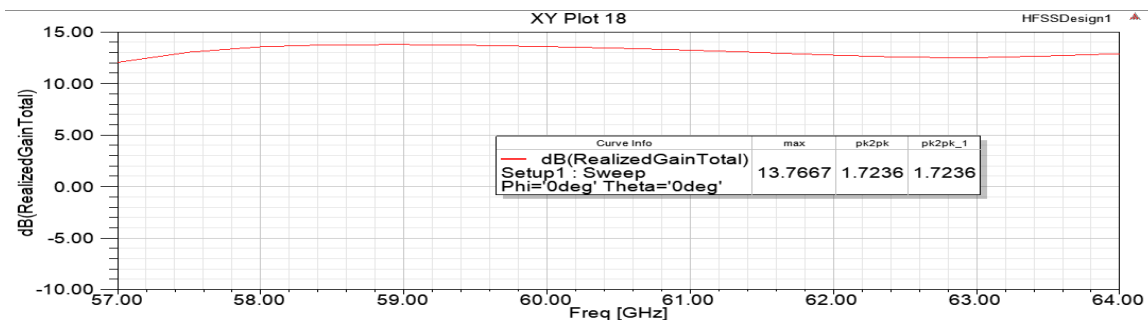

Figure 4.50: Gain in dB of three array E shaped patch antenna without parasitic patches

From the graph the peak gain of the antenna is 13.7667 dB and the flatness of the gain is 1.7236 dB.

The E plane radiation pattern is

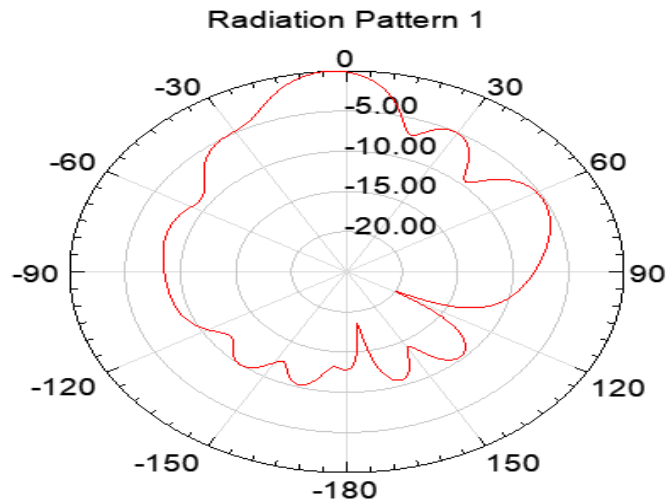

Figure 4.51: E plane radiation pattern of three array E shaped patch antenna without parasitic patches at 60 GHz

From the figure, HPBW of E plane pattern is 20° .

The H plane radiation pattern is

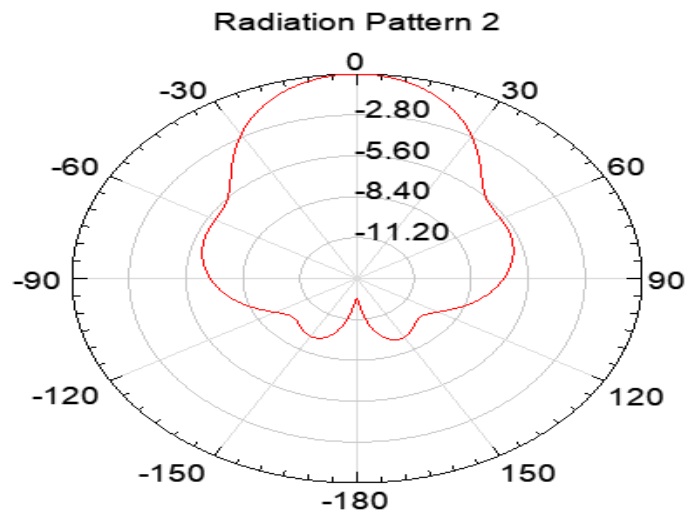

Figure 4.52: H plane radiation pattern of three array E shaped patch antenna without parasitic patches at 60 GHz

From the figure, HPBW of H plane is 62° .

The realized gain on the antenna is

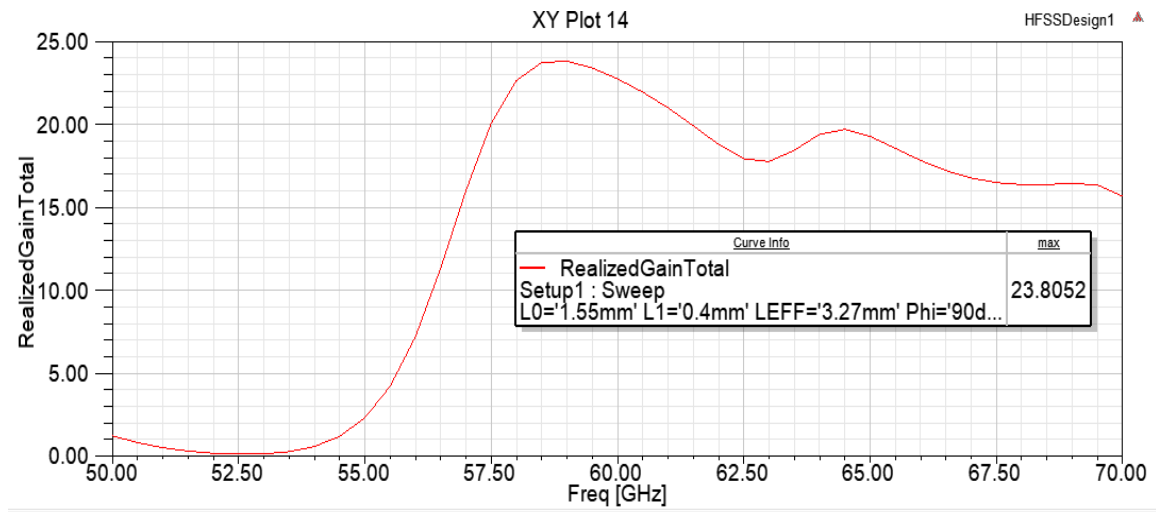

Figure 4.53: Gain of three array E shaped patch antenna without parasitic patches
Peak gain is 23.8052.

From this realized gain the aperture efficiency is found out and the graph is drawn on how aperture efficiency changes with frequency.

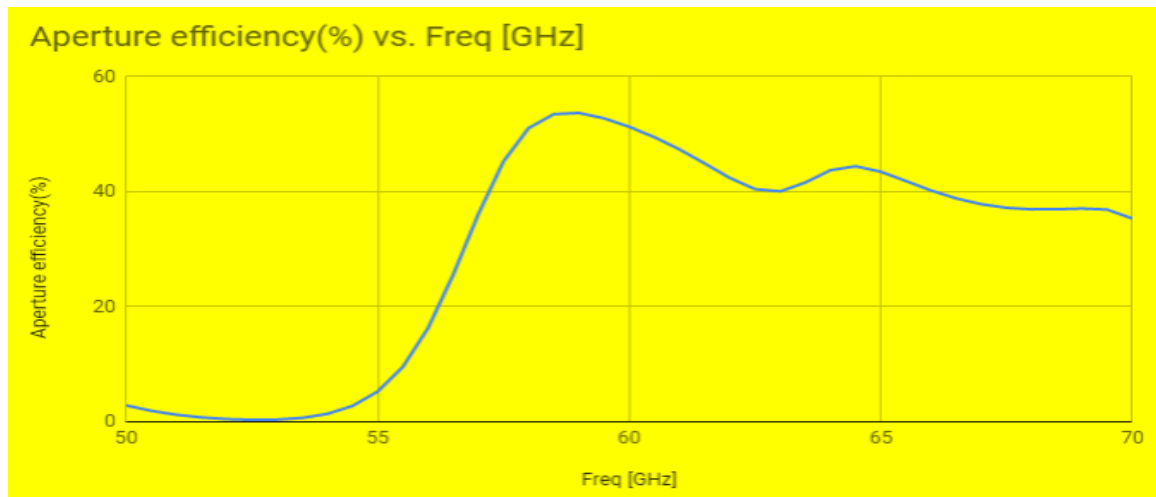

Figure 4.54: Aperture efficiency of three array E shaped patch antenna without parasitic patches

From the graph, the aperture efficiency is high at 59 GHz and the value is 53.67%.

4.3.7 E SHAPED PATCH ANTENNA WITH THREE ARRAY WITH PARASITIC PATCHES

The E shaped patch antenna with three array with parasitic patches will be as shown

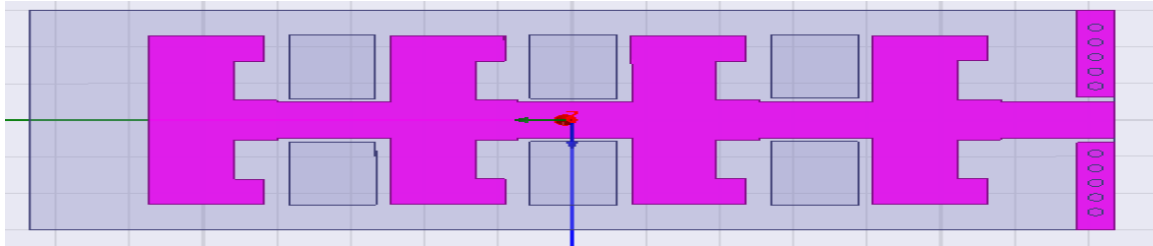

Figure 4.55: Three array E shaped patch antenna with parasitic patches

The return loss of the antenna is

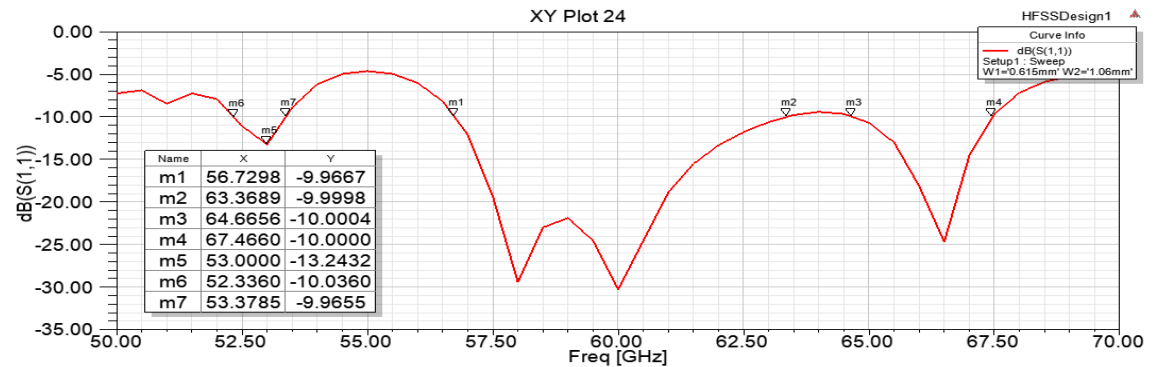

Figure 4.56: Return loss of three array E shaped patch antenna with parasitic patches

The bandwidth is $m_2 - m_1 - m_4 - m_3 - m_7 - m_6 = 10.5$ GHz. Resonance frequency is 53 GHz.

$$\text{Impedance bandwidth} = \frac{m_2 - m_1 - m_4 - m_3 - m_7 - m_6}{52} \times 100\% = 24.51\%$$

The antenna gain will be

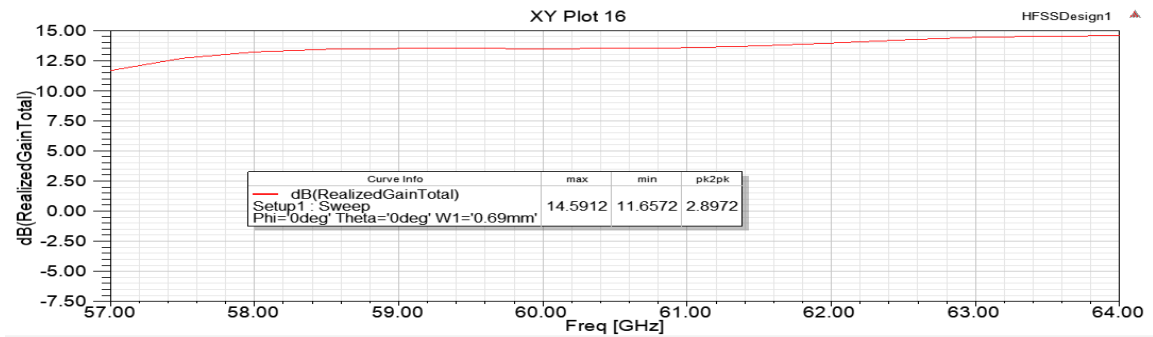

Figure 4.57: Realized gain in dB of three array E shaped patch antenna with parasitic patches

From the graph the peak gain on the antenna is 14.5912 dB. The gain flatness is 2.8972 dB.

The E plane radiation pattern is

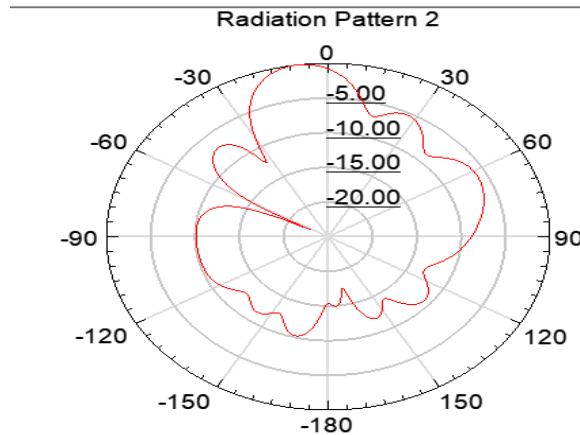

Figure 4.58: E plane radiation pattern of three array E shaped patch antenna with parasitic patches at 60 GHz

From the figure, HPBW of E plane pattern is 20° .

The H plane radiation pattern is

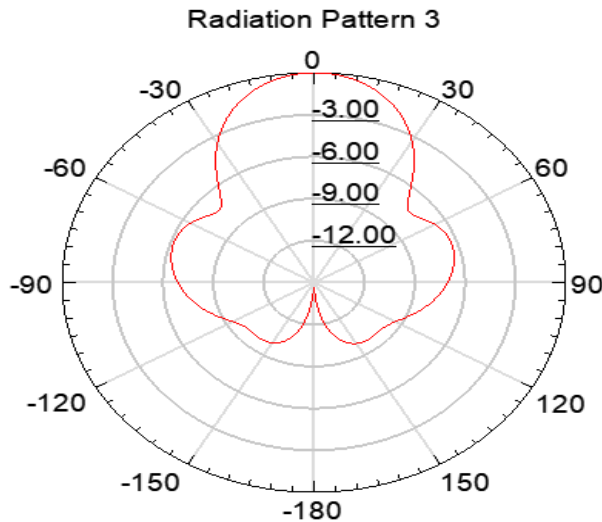

Figure 4.59: H plane radiation pattern of three array E shaped patch antenna with parasitic patches at 60 GHz

From the figure, HPBW of H plane is 62° .

The realized gain on the antenna is

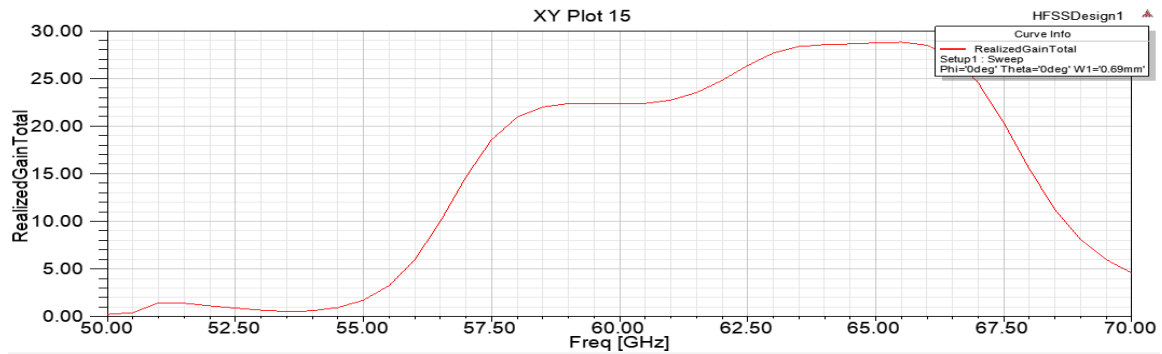

Figure 4.60: Realized gain of three array E shaped patch antenna with parasitic patches

From this realized gain the aperture efficiency is found out and the graph is drawn on how aperture efficiency changes with frequency.

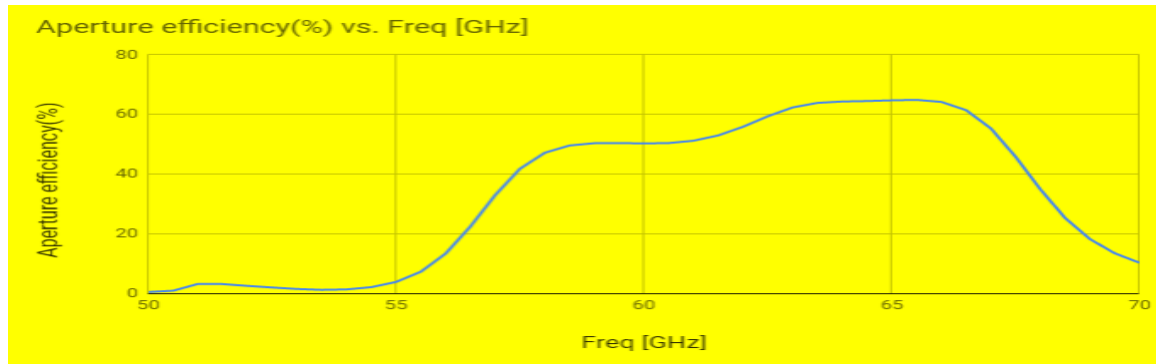

Figure 4.61: Aperture efficiency of three array E shaped patch antenna with parasitic patches

From the graph, the aperture efficiency is high at 65.5 GHz and the value is 64.89%.

4.3.8 E SHAPED PATCH ANTENNA WITH FOUR ARRAY WITHOUT PARASITIC PATCHES

The E shaped patch antenna with four array with parasitic patches will be as shown

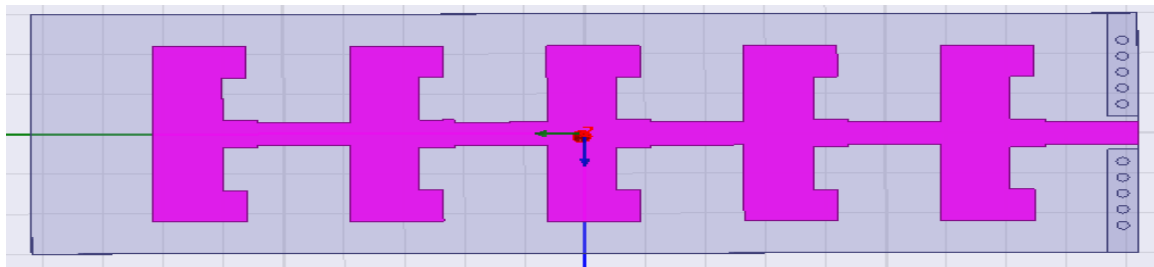

Figure 4.62: Four array E shaped patch antenna without parasitic patches

The return loss of the antenna is

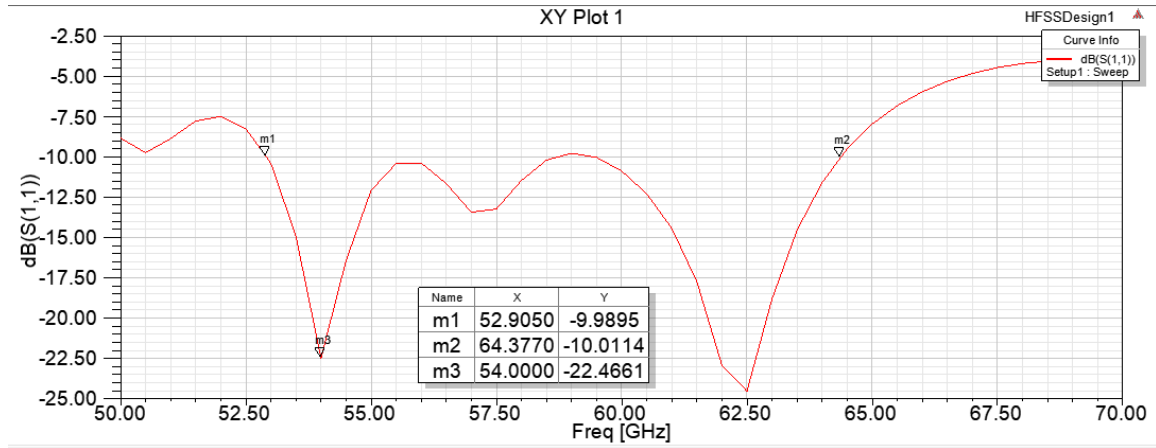

Figure 4.63: Return loss of four array E shaped patch antenna without parasitic patches

The antenna bandwidth is $m2 - m1 = 11.472$ GHz.

The resonant frequency is 54 GHz.

$$\text{Impedance bandwidth} = \frac{m2 - m1}{54} \times 100\% = 21.22\%.$$

The antenna gain will be

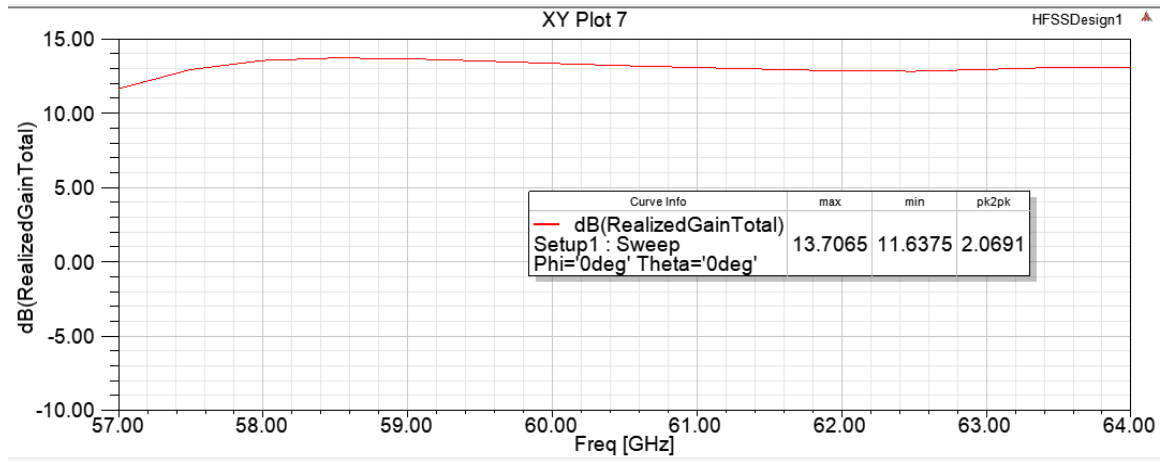

Figure 4.64: Gain in dB of four array E shaped patch antenna without parasitic patches

From the graph the peak gain on the antenna is 13.7605 dB. The gain flatness is 2.0691

dB.

The E plane radiation pattern is

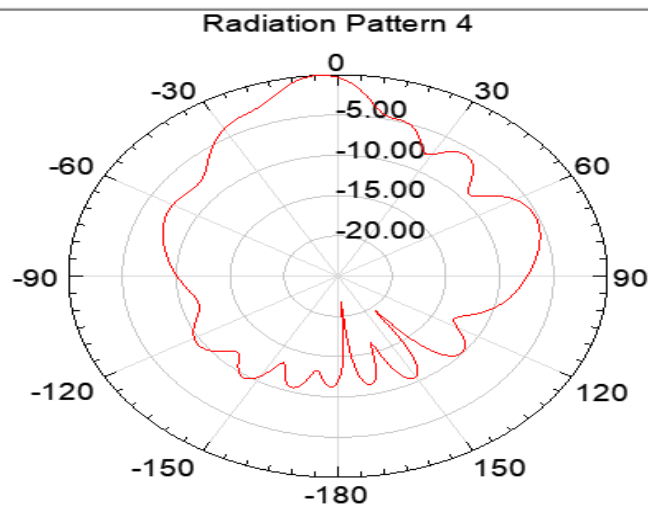

Figure 4.65: E plane radiation pattern of four array E shaped patch antenna without parasitic patches at 60 GHz

From the figure, HPBW of E plane pattern is 34° .

The H plane radiation pattern is

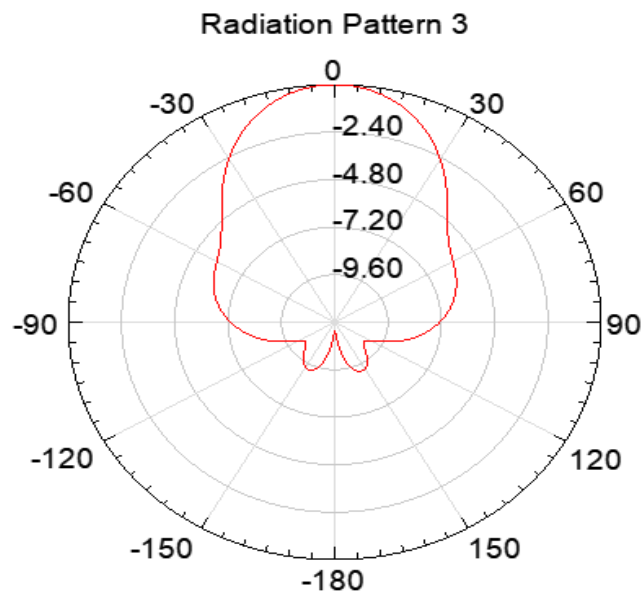

Figure 4.66: H plane radiation pattern of four array E shaped patch antenna without parasitic patches at 60 GHz

From the figure, HPBW of H plane is 66° .

The realized gain on the antenna is

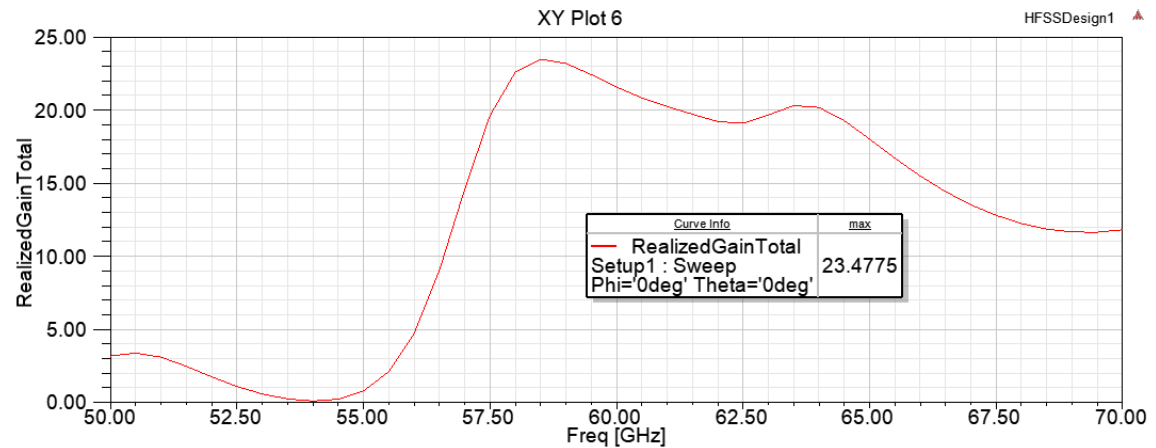

Figure 4.67: E plane radiation pattern of four array E shaped patch antenna without parasitic patches

The peak gain is 23.4775.

From this realized gain the aperture efficiency is found out and the graph is drawn on how aperture efficiency changes with frequency.

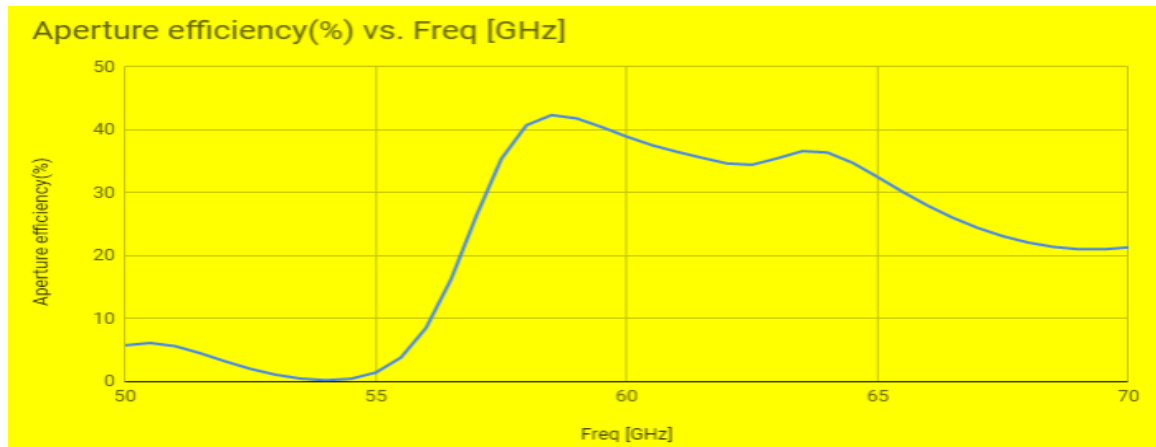

Figure 4.68: Aperture efficiency of four array E shaped patch antenna without parasitic patches

From the graph, the aperture efficiency is high at 58.5 GHz and the value is 42.34%.

4.3.9 E SHAPED PATCH ANTENNA WITH FOUR ARRAY WITH PARASITIC PATCHES

The E shaped patch antenna with two array with parasitic patches will be as shown

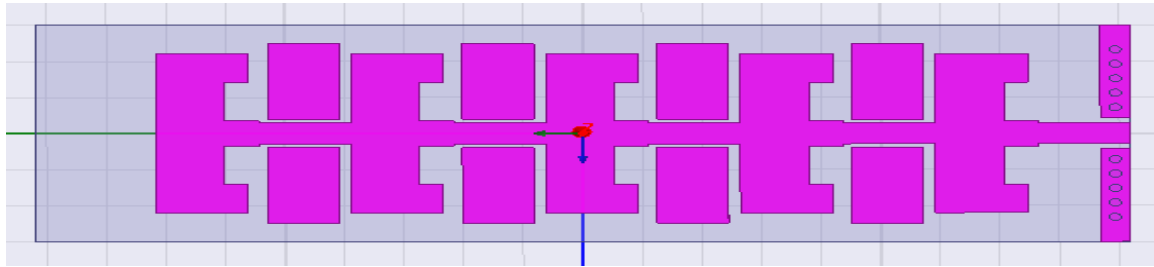

Figure 4.69: Four array E shaped patch antenna with parasitic patches

The return loss of the antenna is

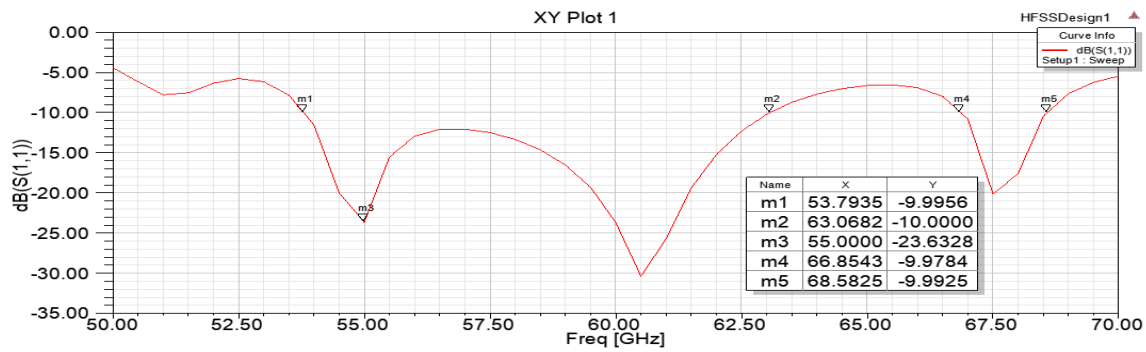

Figure 4.70: Return loss of four array E shaped patch antenna with parasitic patches

From the figure the bandwidth is $m2 - m1 + m5 - m4 = 11.2729$ GHz.

$$\text{Impedance bandwidth} = \frac{m2 - m1 + m5 - m4}{55} \times 100\% = 20.5\%.$$

The antenna gain will be

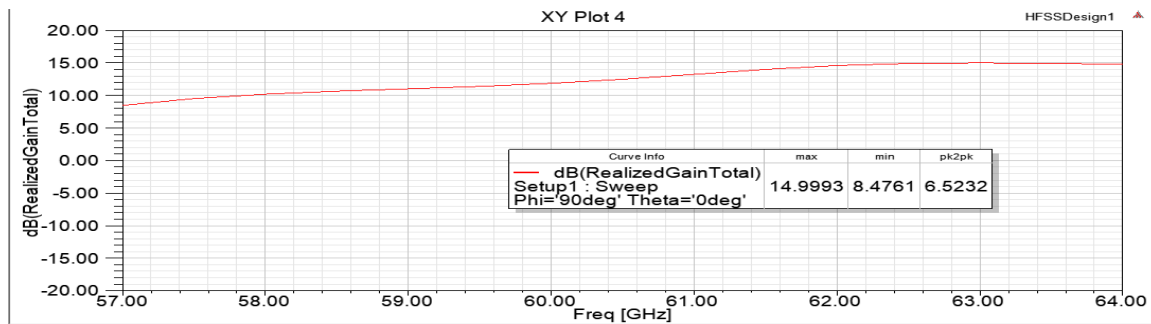

Figure 4.71: Realized gain in dB of four array E shaped patch antenna with parasitic patches

From the graph the peak gain on the antenna is 14.9993 dB. The gain flatness is 6.5232 dB.

The E plane radiation pattern is

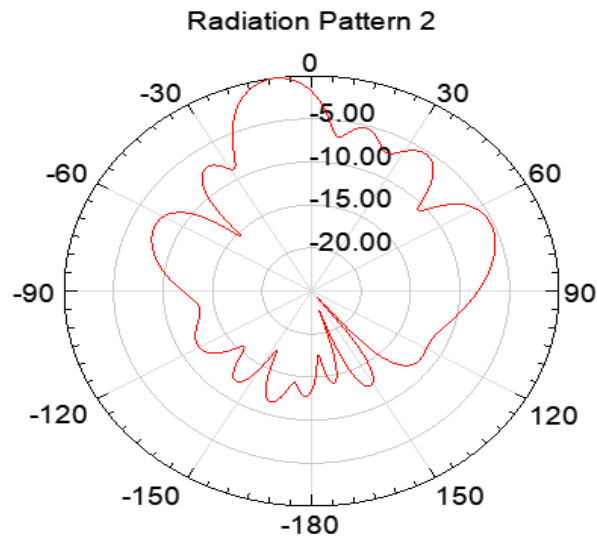

Figure 4.72: E plane radiation pattern of four array E shaped patch antenna with parasitic patches at 60 GHz

From the figure, HPBW of E plane pattern is 24° .

The H plane radiation pattern is

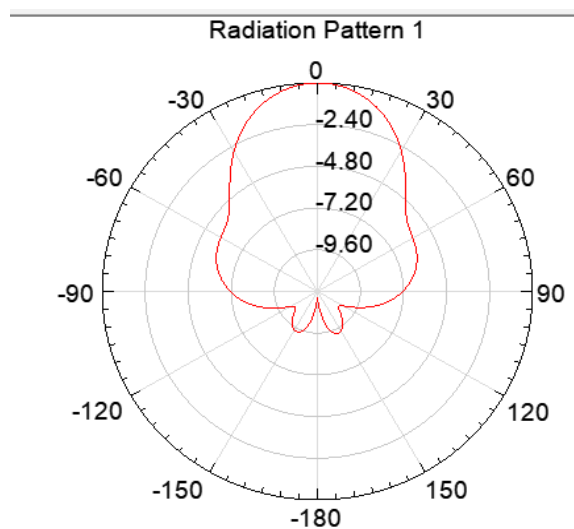

Figure 4.73: H plane radiation pattern of four array E shaped patch antenna with parasitic patches at 60 GHz

From the figure, HPBW of H plane is 64° .

The realized gain on the antenna is

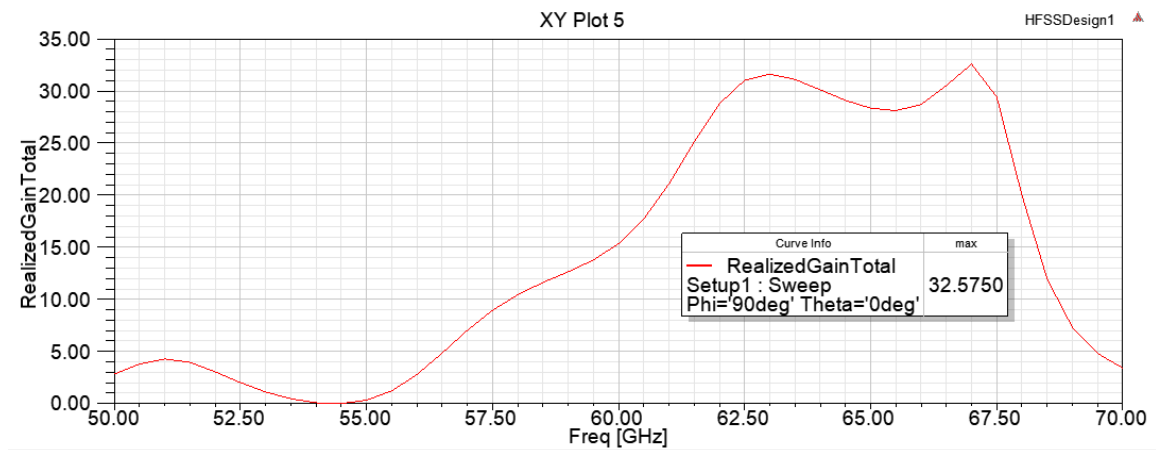

Figure 4.74: Realized gain of four array E shaped patch antenna with parasitic patches
Peak gain is 32.5750.

From this realized gain the aperture efficiency is found out and the graph is drawn on how aperture efficiency changes with frequency.

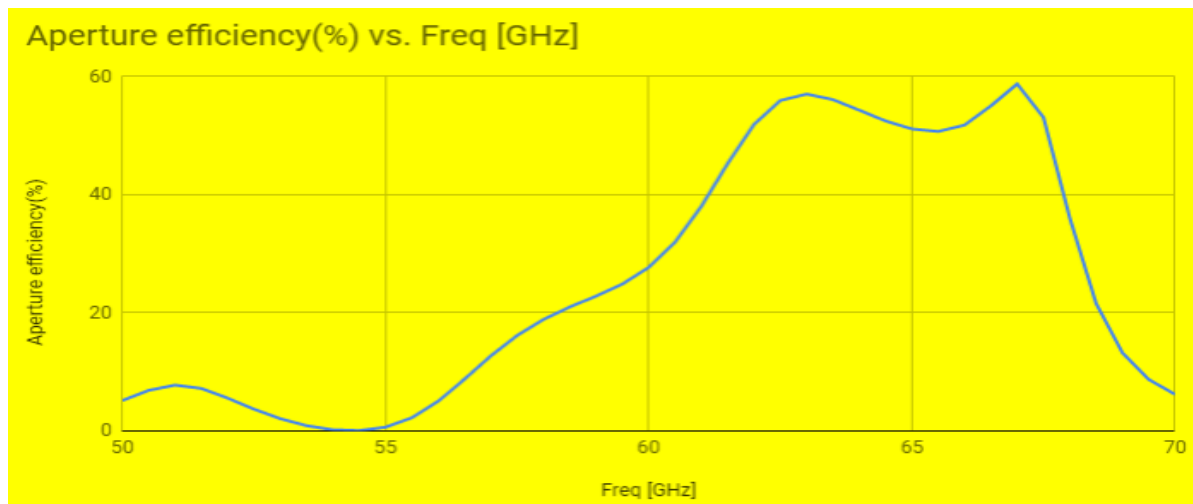

Figure 4.39: Aperture efficiency of four array E shaped patch antenna with parasitic patches

From the graph, the aperture efficiency is high at 63 GHz and the value is 57.03%.

Table 4.4: properties of different E shaped patch antenna arrays

Property\type of antenna	No array	One array without parasitic patches	One array with parasitic patches	Two array without parasitic patches	Two array with parasitic patches	Three array without parasitic patches	Three array with parasitic patches	Four array without parasitic patches	Four array with parasitic patches
Bandwidth (GHz)	3.6449	3.8361	9.149	7.2942	10.8	8.5038	10.482	11.472	11.2729
Impedance Bandwidth in percentage	5.88	6.18	14.87	13.02	20.28	24.51	28.92	21.22	20.5
Peak Gain (dB)	7.8965	11.7293	10.9496	12.8675	14.5672	13.7667	14.5912	13.7605	14.9993
Gain flatness (dB)	2.2481	1.0091	0.6617	0.9058	2.8276	1.726	2.8972	2.0691	6.5232
Aperture Efficiency (%)	41.67	67.15	84.17	28.54	42.93	53.67	64.89	42.34	57.07

CHAPTER 5

CONCLUSION AND FUTURE SCOPE

An E-shaped patch antenna with increase in array structures up to four with and without co polarized parasitic patches is designed at 60-GHz frequency band. Based on table 4.4, as array size increases the antenna bandwidth and peak gain increases. The impedance bandwidth increases up to three array and reduces thereafter. The gain flatness is best for one array. Aperture efficiency is also more for one array. The co polarized parasitic patches resonates at higher frequency than the E-shaped patch. By this there is an increase in the gain of the antenna over the same area. The gain flatness and aperture efficiency are also improved. On comparison of all parameters three array antenna is best at 60 GHz. This three array antenna is having dimensions as $6.0 \times 14.7 \times 0.25\text{mm}^3$. The three array antenna with and without parasitic patches is having 2.8 dB and 1.7 dB gain flatness over the 60 GHz band (57 – 66 GHz), 14.5 dBi and 13.8 dBi peak gain, and 64.9% and 53.7% aperture efficiency respectively, without any change in the dimensions of antenna.

The future work is to fabricate this antenna on a PCB to reduce the cost of manufacturing. The fabricated antenna is to be measured using special equipment suitable for 60 GHz. The measured and simulated values are to be compared.

REFERENCES

- [1] F. Yang, X.-X. Zhang, X. Ye, and Y. Rahmat-Samii, "Wide-band E-shaped patch antennas for wireless communications," *IEEE Trans. Antennas Propag.*, vol. 49, no. 7, pp. 1094–1100, Jul. 2001.
- [2] C. A. Balanis, *Antenna Theory: Analysis and Design*, 3rd ed. New York, NY, USA: Wiley, 2005.
- [3] J. J. Lee and C. S. Park, "60-GHz gigabits-per-second OOK modulator with high output power in 90-nm CMOS," *IEEE Trans. Circuits Syst. II, Express Briefs*, vol. 58, no. 5, pp. 249–253, May 2011.
- [4] B. Zhang and Y. P. Zhang, "Grid array antennas with sub arrays and multiple feeds for 60-GHz radios," *IEEE Trans. Antennas Propag.*, vol. 60, no. 5, pp. 2270–2275, May 2012.
- [5] Y. Wang, "A series feed E-shaped microstrip antenna with high gain," in *Proc. Int. Symp. Antennas Propag.*, pp. 175–178, Oct. 2012.
- [6] H. Chu, Y. X. Guo, and Z. Wang, "60-GHz LTCC wideband vertical off-center dipole antenna and arrays," *IEEE Trans. Antennas Propag.*, vol. 61, no. 1, pp. 153–161, Jan. 2013.
- [7] L. Wang, Y. X. Guo, and W. X. Sheng, "Wideband high-gain 60-GHz LTCC L-probe patch antenna array with a soft surface," *IEEE Trans. Antennas Propag.*, vol. 61, no. 4, pp. 1802–1809, Apr. 2013.
- [8] Z. Briqech, A. R. Sebak, and T. A. Denidni, "High-efficiency 60-GHz printed yagi antenna array," *IEEE Antennas Wireless Propag. Lett.*, vol. 12, pp. 1224–1227, 2013.

- [9] C. W. Byeon, C. H. Yoon, and C. S. Park, "A 67-mW 10.7-Gb/s 60-GHz OOK CMOS transceiver for short-range wireless communications," *IEEE Trans. Microw. Theory Techn.*, vol. 61, no. 9, pp. 3391–3401, Sep. 2013.
- [10] K.-S. Chin, W. Jiang, W. Che, C.-C. Chang, and H. Jin, "Wideband LTCC 60-GHz antenna array with a dual-resonant slot and patch structure," *IEEE Trans. Antennas Propag.*, vol. 62, no. 1, pp. 174–182, Jan. 2014.
- [11] Y. Li and K.-M. Luk, "A 60-GHz dense dielectric patch antenna array," *IEEE Trans. Antennas Propag.*, vol. 62, no. 2, pp. 960–963, Feb. 2014.
- [12] T. Jang, H. Y. Kim, I. S. Song, C. J. Lee, and C. S. Park, "Low profile wideband E-shaped patch antenna for 60 GHz communication," in *Proc. Asia Pacific Microw. Conf. (APMC)*, Nanjing, China, pp. 1440–1442, Dec. 2015.
- [13] Yao Demiao, Cai Jianming, "Study of the wide-band and high-gain microstrip antenna element," *Journal of Electronics*, vol. 5, pp. 526-531, 1996.
- [14] Liang Bin, Yang Na, "A new high gain microstrip antenna," *Digital Communication*, vol. 10, pp. 62-64, 2009.
- [15] Yong Xin Guo, Kwai Man Luk and Kai-Fong Lee, "L-Probe Fed Thick Substrate Patch Antenna Mounted on a Finite Ground Plane," *IEEE Trans. Antennas Propagat.* vol. 51, pp. 1955-1963, 2003.
- [16] Yong Xin Guo, Chi Lun Mak, Kwai Man Luk and Kai-Fong Lee, "Analysis and Design of L-Probe Proximity Fed-Patch Antennas," *IEEE Trans. Antennas Propagat.* vol. 49, pp. 145-149, 2001.

- [17] Rathi Vivek, Kumar Girish, Ray K P, "Improved coupling for aperture coupled microstrip antennas," IEEE Trans on antennas and Propagation. vol. 44, pp.1196-1198, 1996.
- [18] Yuehe Ge, Karu P. Esselle, and Trevor S. Bird, "E-Shaped Patch Antennas for High-Speed Wireless Networks," IEEE Trans. Antennas Propagat. vol. 52, pp. 3213-3219, 2004.
- [19] Sailing He, Zhinong Ying, Jiang Xiong, "A broadband e-shaped patch antenna of compact size and low profile," Antennas and Propagation Society International Symposium, 2008.
- [20] Yikai Chen, Shiwen Yang, and Zaiping Nie, "Bandwidth enhancement method of low profile E-shaped microstrip patch antennas," IEEE Trans. Antennas Propagat.vol.58: pp. 2442-2447, 2010.
- [21] Yu feng Wang, Chuan Gong, Xin Chao Lin, "Wide-band L-probe fed E shaped microstrip antenna with high gain and high cross-polarized isolation," Communication Countermeasures, vol. 115, pp. 47-51, 2011.
- [22] Xu Yan, Zhang Lidong, "The design and simulation of rectangular microstrip standing-wave antenna array," Guidance & Fuze, vol. 24, pp. 37-41, 2003.
- [23] K. Gong, Z. N. Chen, X. Q, P. Chen, and W. Hong, "Substrate integrated waveguide cavity-backed wide slot antenna for 60-GHz bands", IEEE Trans. Antennas Propag., vol. 60, no.12, pp. 6023-6026, Dec. 2012.
- [24] H. Sun, Y. Guo, and Z. Wang, "60-GHz circularly polarized U-slot patch antenna array on LTC", IEEE Trans. Antennas Propag., vol. 61, no.1, pp. 430-435, Jan. 2013.

- [25] G. Kumar and K. C. Gupta, "Directly coupled multiple resonator wide-band microstrip antenna," *IEEE Trans. Antennas Propagat.*, vol. AP-33, pp. 588–593, June 1985.
- [26] D. M. Pozar, "Microstrip antenna coupled to a microstrip-line," *Electron. Lett.*, vol. 21, no. 2, pp. 49–50, Jan. 1985.
- [27] K. L. Virga and Y. Rahmat Samii, "Low profile enhanced-bandwidth PIFA antennas for wireless communications packaging," *IEEE Trans. Microwave Theory Tech.*, vol. 45, pp. 1879–1888, Oct. 1997.
- [28] I. Papapolymerous, R. F. Drayton, and L. P. B. Katehi, "Micro machined patch antennas," *IEEE Trans. Antennas Propagat.*, vol. 46, pp. 275–283, Feb. 1998.
- [29] N. Herscovici, "New considerations in the design of microstrip antennas," *IEEE Trans. Antennas Propagat.*, vol. 46, pp. 807–812, June 1998.
- [30] T. Huynh and K. F. Lee, "Single-layer single-patch wideband microstrip antenna," *Electron. Lett.*, vol. 31, no. 16, pp. 1310–1312, Aug. 1995.
- [31] E. H. Newman and P. Tulyathan, "Analysis of microstrip antennas using moment methods," *IEEE Trans. Antennas Propagat.*, vol. AP-29, pp. 47–53, Jan. 1981.
- [32] S. M. Rao, D. R. Wilton, and A. W. Glisson, "Electromagnetic scattering by surfaces of arbitrary shape," *IEEE Trans. Antennas Propagat.*, vol. AP-30, pp. 409–418, May 1982.
- [33] K. C. Gupta and A. B. Norwood, "Microstrip Antenna Design," Norwood, MA: Artech House, 1988.

[34] X. X. Zhang and F. Yang, "The study of slit cut on the microstrip antenna and its applications," *Microwave Opt. Technol. Lett.*, vol. 18, no. 4, pp. 297–300, July 1998.

[35] Y. Rahmat Samii and E. Michielssen, *Electromagnetic Optimization by Genetic Algorithms*. New York, NY: Wiley, 1999.

[36] R. E. Hodges and Y. Rahmat Samii, "An iterative current-based hybrid method for complex structures," *IEEE Trans. Antennas Propagat.*, vol. 45, pp. 265–276, Feb. 1997.